

### Configuration – Device Display

The Time Sync Hub features a color touchscreen display that supports initial configuration of Ethernet communication parameters. To configure Ethernet or confirm settings, select the “Setup” (gear) icon followed by the “Network” button.

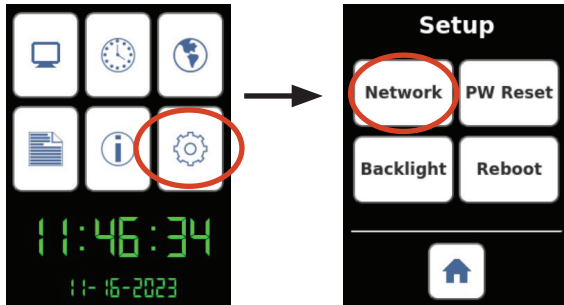

Time Sync Hub Touchscreen

To Enable DHCP, select the “DHCP Enable” check box. To configure a static IP address, select the ‘IP Addr’, ‘Netmask’ and Gateway buttons.

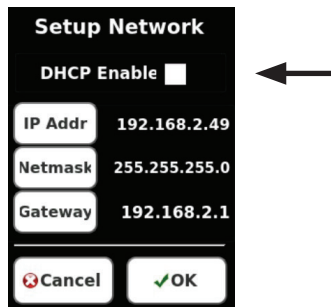

Time Sync Hub Touchscreen

Select the ‘OK’ button to save settings.

### Configuration – Web Interface

Configuration of the Time Sync Hub can be accomplished using the device’s secure web server.

#### To connect a PC to the Time Sync Hub: (Optional)

- 1) Connect your PC to the Time Sync Hub using a standard Ethernet patch cable.
- 2) Set PC to use static IP address 169.254.0.11.
- 3) Apply power to the Time Sync Hub.
- 4) Open a standard web browser, such as Microsoft™ Edge or Google™ Chrome.
- 5) Type the Time Sync Hub’s default IP address (169.254.0.10) into your web browser.
- 6) Enter the default user name (admin) and password (admin\*) and click “Login”.
- 7) Click the Setup tab to configure: Communications, Time, and device Administration.

*\* During initial Login, you will be prompted to change the password.*

*For detailed information about the Trystar Time Sync Hub, refer to the Time Sync Hub User Guide.*

For general information visit:  
[www.TRYPSTAR.com](http://www.TRYPSTAR.com)



Document Number: 0500IB0724  
July -2024

The Trystar service marks and Trystar stylized logos are trademarks of Trystar. All other trademarks are the property of their respective owners.

### Quick Start Guide

The Trystar® Time Sync Hub (TSH-100, TSH-200) supplies accurate time synchronization for items such as; Sequence of Events Recorders (SERs), power meters, protective relays, transfer switches UPS, PLCs and other devices used across your power distribution system.

#### Key Features:

##### - Time Synchronization Inputs:

**TSH-100:** Precision Time Protocol (PTP), Network Time Protocol (NTP)

**TSH-200:** Precision Time Protocol (PTP), Network Time Protocol (NTP), GNSS (GPS), IRIG-B (unmodulated), DCF77 (5 Vdc), RS-485 (IRIG-B, DCF77)

##### - Time Synchronization Outputs:

**TSH-100/TSH-200:** PTP, NTP, IRIG-B (unmodulated), DCF77, PPS, 1per10, Arbiter ASCII (RS-485)

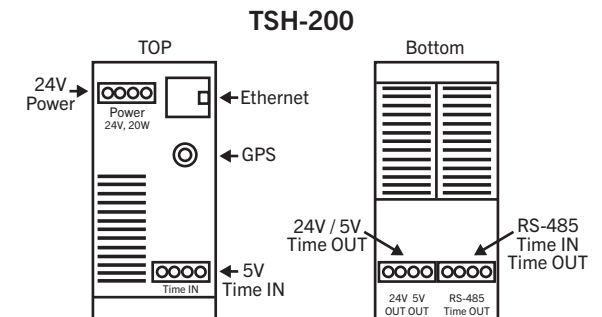

**Package Contents:** Time Sync Hub. Plug-in connectors, Quick Start Guide.

## DANGER

### HAZARD OF ELECTRICAL SHOCK, EXPLOSION, OR ARC FLASH

- Only qualified workers should install this equipment. Such work should be performed only after reading this entire set of instructions.
- Never work alone.
- Before performing visual inspections, tests, or maintenance on this equipment, disconnect all sources of electric power. Assume all circuits are live until they have been completely de-energized, tested and tagged. Pay particular attention to the design of the power system. Consider all sources of power, including the possibility of back feeding.
- Apply appropriate personal protective equipment (PPE) and follow safe electrical practices. For example, in the USA, see: NFPA 70E.
- Turn off all power supplying the equipment in which the device is to be installed before installing and wiring the device.
- Always use a properly rated voltage sensing device to confirm power is off.
- Beware of potential hazards, wear PPE, and carefully inspect the work area for tools and objects that may have been left inside the equipment.
- The successful operation of this equipment depends upon proper handling, installation and operation. Neglecting fundamental installation requirements may lead to personal injury as well as damage to electrical equipment or other property.

**Failure to follow these instructions can result in death or serious injury.**

## Installation

The Time Sync Hub is mounted to a standard DIN rail by engaging the top edge of the rail first and rotating downward to lock the unit into place.

## Wiring Recommendations

- 18 AWG (Belden 8760) shielded twisted pair cable is recommended for use for all input and output connections.
- DIN rail should be connected to Earth ground.
- UF-400 ultra-flexible coax cable is recommended for the GPS antenna.
- A surge suppressor (GPS-SS) should be installed as close to the building entrance as possible for the GPS antenna cable.
- Ethernet communications cable should be CAT5 or better.

### STEP 1 - Control Power

The Time Sync Hub can receive control power from either a nominal 24 VDC, 20 VA, Class 2 control power source or a Power over Ethernet, Type 2 (30W) source.

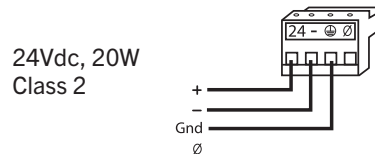

### STEP 2 – Time Signal Input

The Time Sync Hub can receive time synchronization input via Ethernet (PTP or NTP) or RS-485 (IRIG-B or DCF77). Additionally, the TSH-200 can receive time input from a GPS antenna or dedicated wiring to a 5 Vdc input (IRIG-B or DCF77).

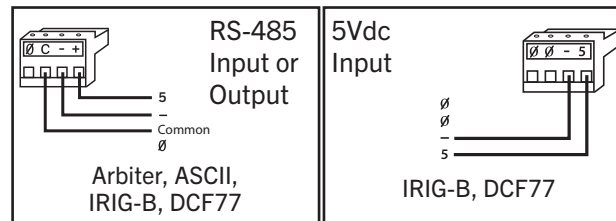

## GPS Connection

The Time Sync Hub (TSH-200) GNSS (GPS) utilizes a bullet style antenna (50 ohm, 3.3 Vdc active).

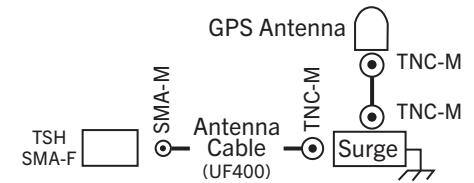

### STEP 3 – Time Signal Output(s)

The Time Sync Hub can output multiple time synchronization signals concurrently via Ethernet (PTP, NTP), RS-485 (IRIG-B or DCF77), 24 Vdc output (DCF77, IRIG-B, PPS, 1per10) and 5 Vdc output (IRIG-B, DCF77, PPS, 1per10).

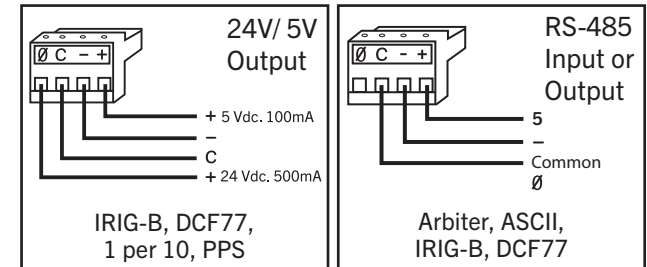

Time synchronization outputs may be limited based on the time source input being utilized. The following table defines allowed configurations.

**NOTE:** Only one time output signal may be assigned to a physical port. (i.e. both IRIG-B and DCF77 cannot be both assigned to the 5V output; the RS-485 port cannot concurrently input and output time signals)