

OZPCS-RS40

Power Conversion System

OZpcs-RS40 SB

40kW Energy Storage

Power Conversion System

Rack Scale™ Series

USER MANUAL
UM-0075



About Oztek

Oztek Corp. is a proven innovator of power, control, and instrumentation solutions for the most demanding industrial applications. Oztek products include variable motor drives, grid tie inverters, frequency converters, standalone inverters, DC/DC converters, and DSP based control boards for power control applications.

Trademarks

OZpcs and Power Studio are trademarks of Oztek Corp. Other trademarks, registered trademarks, and product names are the property of their respective owners and are used herein for identification purposes only.

Notice of Copyright

OZpcs-RS40 SB 40kW Energy Storage PCS User's Manual © April 2022 Oztek Corp. All rights reserved.

Exclusion for Documentation

UNLESS SPECIFICALLY AGREED TO IN WRITING, Oztek Corp. ("Oztek")

- (A) MAKES NO WARRANTY AS TO THE ACCURACY, SUFFICIENCY OR SUITABILITY OF ANY TECHNICAL OR OTHER INFORMATION PROVIDED IN ITS MANUALS OR OTHER DOCUMENTATION.

- (B) ASSUMES NO RESPONSIBILITY OR LIABILITY FOR LOSSES, DAMAGES, COSTS OR EXPENSES, WHETHER SPECIAL, DIRECT, INDIRECT, CONSEQUENTIAL OR INCIDENTAL, WHICH MIGHT ARISE OUT OF THE USE OF SUCH INFORMATION. THE USE OF ANY SUCH INFORMATION WILL BE ENTIRELY AT THE USER'S RISK.

- (C) IF THIS MANUAL IS IN ANY LANGUAGE OTHER THAN ENGLISH, ALTHOUGH STEPS HAVE BEEN TAKEN TO MAINTAIN THE ACCURACY OF THE TRANSLATION, THE ACCURACY CANNOT BE GUARANTEED. APPROVED OZTEK CONTENT IS CONTAINED WITH THE ENGLISH LANGUAGE VERSION WHICH IS POSTED AT WWW.OZTEKCORP.COM.

Date and Revision

July 2024 Rev N

Part Number

UM-0075

Contact Information

USA

Telephone: 603-546-0090

Email techsupport@oztekc corp.com

IMPORTANT SAFETY INSTRUCTIONS

SAVE THESE INSTRUCTIONS

This manual contains important instructions for the Ozpcs-RS40 power conversion system (PCS), that shall be followed during installation and maintenance of the PCS. The Ozpcs-RS40 is designed and tested according to international safety requirements, but as with all electrical and electronic equipment, certain precautions must be observed when installing and/or operating the PCS. To reduce the risk of personal injury and to ensure the safe installation and operation of the Ozpcs-RS40, you must carefully read and follow all instructions, cautions and warnings in this installation guide.

Warnings in this Document

The following safety notices are provided for your safety and as a means of preventing damage to the product or components in the application. Specific Dangers, Warnings, and Cautions are listed at the beginning of the relevant sections and are repeated or supplemented at critical points throughout these sections. Please read the information carefully since it is provided for your personal safety and will also help prolong the service life of your PCS and the equipment you connect to it.



DANGER

This symbol indicates high voltage. It calls your attention to items or operations that could be dangerous to you and other persons operating this equipment. Read the message and follow the instructions carefully.



WARNING

Indicates a potentially hazardous situation which, if not avoided, can result in serious injury or death.



CAUTION

Indicates a potentially hazardous situation which, if not avoided, can result in minor to moderate injury, or serious damage to the product. The situation described in the CAUTION may, if not avoided, lead to serious results. Important safety measures are described in CAUTION (as well as WARNING).

Table of Contents

1. Introduction	2
1.1 Referenced Documents	2
1.2 General Information	2
1.3 General Safety	3
1.4 Orderable Part Numbers	4
2. Specifications.....	5
2.1 Reliability	5
2.2 Electrical Specifications	5
2.3 Environmental Specifications (Indoor use)	7
2.4 Mechanical Specifications	7
2.5 Accuracies.....	7
2.6 Mechanical Dimensions.....	8
2.7 Temperature Based Power Derating	10
2.8 DC Input Voltage Based Power Derating.....	12
2.9 AC Voltage Based Power Derating.....	13
2.10 Elevation Based Power Derating	14
2.11 Maintenance.....	15
2.12 Regulatory Specifications	15
2.12.1 Listings (See Appendix A)	15
2.12.2 Compliance.....	15
3. Unpacking and Inspection	16
4. Installation	17
4.1 Mechanical	17
4.2 Electrical	18
4.2.1 DC Connection.....	19
4.2.2 AC Connection.....	20
4.2.3 Low Voltage I/O.....	22
4.2.4 Configuration.....	23
5. Interface.....	23
5.1 Visual Indicators	23
5.2 Low Voltage I/O	24
5.2.1 Modbus RS-485	24
5.2.2 Inputs.....	25
5.2.2.1 Emergency Stop.....	25
5.2.2.2 Bias On/Off	26
5.2.2.3 Island Control Input	26
5.2.3 Outputs.....	26
6. Operation	27
6.1 Bias Power	28
6.2 Grid Tie Operating Mode.....	28
6.2.1 Initiating Grid Tie Operation	28
6.2.2 Enabling Service	29
6.2.3 Active Power Control	30
6.2.3.1 Limit Maximum Active Power	30
6.2.3.2 Volt/Watt Control.....	31
6.2.3.3 Frequency/Watt Control	32
6.2.3.4 Prioritization of Active Power Limiting Functions	34
6.2.4 Reactive Power Control.....	35

6.2.4.1	Constant Reactive Power Control.....	35
6.2.4.2	Power Factor Control	36
6.2.4.3	Volt/VAR Control	37
6.2.4.4	Watt/VAR Control.....	39
6.2.5	Output Power and Current Limiting.....	40
6.2.6	Unbalanced Voltage Compensation.....	41
6.2.6.1	Negative Sequence Current Control.....	41
6.2.6.2	Negative Sequence Current Limit and Priority	41
6.2.7	Anti-Island Detection	42
6.2.8	Grid Fault Ride Through	42
6.2.8.1	Low/High Voltage Ride Through.....	43
6.2.8.2	Low/High Frequency Ride Through	46
6.3	Grid Forming (Island) Operating Mode	47
6.3.1	Initiating Grid Forming Operation	49
6.3.2	Parallel Black Start.....	50
6.3.3	Microgrid Monitoring.....	50
6.3.4	Single Unit Standalone Operation.....	50
6.4	Changing Operating Modes.....	51
6.4.1	Passive Mode Changes.....	51
6.4.2	Seamless Mode Changes.....	52
6.5	Operating States.....	52
6.5.1	Initialize	54
6.5.2	Calibrate	54
6.5.3	Disabled.....	54
6.5.4	Charge Wait.....	54
6.5.5	Charging	54
6.5.6	Standby.....	55
6.5.7	Turn-On Delay	55
6.5.8	Online – Grid Tie.....	55
6.5.9	Online – Grid Form	55
6.5.10	Offline.....	56
6.5.11	Ride Through	56
6.5.12	Turn Off	56
6.5.13	Island Transfer Wait	57
6.5.14	Fault.....	57
6.5.15	Service Disabled	57
6.5.16	Shutdown	58
7.	Fault and Warning Conditions	58
7.1	Warnings.....	58
7.1.1	High Inverter Current – Phase A, B, C	58
7.1.2	High Grid Voltage	58
7.1.3	PLL Not Locked	58
7.1.4	Loss of Phase	59
7.1.5	AC Current Limit	59
7.1.6	DC Power Limit.....	59
7.1.7	AC Power Limit	59
7.1.8	AC Current Overload	59
7.1.9	Grid Out of Tolerance (OOT)	60

7.1.10	Resume – Delay	60
7.1.11	Island Detected	60
7.1.12	High DC Current	60
7.1.13	Temperature Warning	60
7.1.14	Low DC Voltage	60
7.1.15	High DC Voltage	61
7.1.16	Fan Warning	61
7.1.17	HVRT Active Override	61
7.1.18	TVS Error	61
7.1.19	Volt-VAR Active	61
7.1.20	Watt-VAR Active	61
7.1.21	Volt-Watt Active	61
7.1.22	Frequency-Watt Active	62
7.1.23	Limit Active Power	62
7.1.24	Negative Sequence Current Limit	62
7.2	Faults	62
7.2.1	H/W and S/W Inverter Over-Current A, B, C	62
7.2.2	AC Over-Voltage AB, BC, CA	63
7.2.3	Ride Through – Low/High Voltage/Frequency	63
7.2.4	Grid Island Condition	63
7.2.5	Emergency Stop	63
7.2.6	Communications Heartbeat Fault	63
7.2.7	Power Down Error	64
7.2.8	Invalid User Configuration	64
7.2.9	Invalid Model	64
7.2.10	H/W and S/W DC Over-Voltage	64
7.2.11	DC Over-Current	64
7.2.12	DC Under-Voltage	64
7.2.13	Temperature Faults	64
7.2.14	Saturation Error A, B, C	65
7.2.15	AC Current Overload Trip	65
7.2.16	Internal Factory Fault	65
8.	Real Time Clock (RTC)	66
8.1	Real Time Clock – Date Format	67
8.2	Real Time Clock – Time Format	67
8.3	Setting the Date and Time	67
8.4	Reading the Date and Time	67
9.	Data Logging	67
9.1	Event Data Logging	67
9.1.1	Fault Events	69
9.1.2	User Events	71
9.1.2.1	Selecting Parameters	71
9.1.2.2	Setting the Sample Period and Post Trigger Size	71
9.1.2.3	Configuring the Trigger Mode	72
9.1.2.4	Configuring Triggers	72
9.1.2.5	Reading the Log	73
9.2	Fault History Log	75
9.2.1	Fault Count Log	75
9.2.2	Fault Time Stamp Log	76

9.3	Operating History Logs	77
9.3.1	Operating Time Log	77
9.3.2	Min/Max Log	81
10.	Communications Interface	83
10.1	Modbus Overview	83
10.2	Physical Layer	84
10.3	RTU Transmission Mode.....	85
10.3.1	Synchronization.....	85
10.3.2	Slave Address	85
10.3.3	Function Code	85
10.3.4	Data Field	86
10.3.5	CRC Error Check.....	86
10.3.6	Exception Response	87
10.4	Function Code Descriptions.....	87
10.4.1	Read Holding Registers (Function Code 03).....	87
10.4.2	Preset Single Command Register (Function Code 06).....	88
10.4.3	Write Multiple Registers (Function Code 16).....	89
11.	SunSpec Device Information Models	90
11.1	Register Properties	91
11.1.1	Register Number	91
11.1.2	Access Level.....	92
11.1.3	SunSpec Data Formats	92
11.1.4	SunSpec Data Type U16	92
11.1.5	SunSpec Data Type S16.....	92
11.1.6	SunSpec Data Type U32	93
11.1.7	SunSpec Data Type S32	93
11.1.8	SunSpec Data Type U64	93
11.1.9	SunSpec Data Type String.....	94
11.2	SunSpec Curve-Based Register Models	94
11.2.1	Curve Sets.....	95
11.2.2	Adopting a New Curve	95
11.3	Register Models.....	96
11.3.1	SunSpec Identifier	97
11.3.2	SunSpec Model 1 Registers – Common Model	97
11.3.3	SunSpec Model 17 Registers – Serial Interface.....	98
11.3.4	SunSpec Model 701 Registers – DER AC Measurement.....	98
11.3.5	SunSpec Model 702 Registers – DER Capacity	100
11.3.6	SunSpec Model 703 Registers – Enter Service	102
11.3.7	SunSpec Model 704 Registers – DER AC Controls.....	103
11.3.8	SunSpec Model 705 Registers – DER Volt-VAR	104
11.3.9	SunSpec Model 706 Registers – DER Volt-Watt.....	106
11.3.10	SunSpec Model 707 Registers – DER Low Voltage Trip (LVRT)	108
11.3.11	SunSpec Model 708 Registers – DER High Voltage Trip (HVRT).....	109
11.3.12	SunSpec Model 709 Registers – DER Low Frequency Trip (LFRT)	111
11.3.13	SunSpec Model 710 Registers – DER High Frequency Trip (HFRT).....	113
11.3.14	SunSpec Model 711 Registers – DER Frequency Droop (Freq-Watt).....	115
11.3.15	SunSpec Model 712 Registers – DER Watt-VAR.....	116
11.3.16	SunSpec Model 714 Registers – DER DC Measurement	117
11.3.17	SunSpec Model 715 Registers – DER Control.....	118

11.3.18 Oztek Extension Model 64340 Registers – Control and Status.....	119
11.3.19 Oztek Extension Model 64341 Registers – Configuration.....	124
11.3.20 Oztek Extension Model 64302 Registers – Alarms.....	126
11.3.21 Oztek Extension Model 64304 Registers – Firmware Update.....	129
11.3.22 Oztek Extension Model 64305 Registers – Datalogging.....	130
11.3.23 Oztek Extension Model 64308 Registers – Grid Forming Configuration & Control	135
11.3.24 SunSpec Model 0xFFFF Registers – End Model.....	137
12. Servicing the Unit.....	138
13. Maintenance and Upgrade.....	138
13.1 Firmware Updates	138
14. Oztek Power Studio™ Tool	139
15. Appendix A – Records of Certification	141
Warranty and Product Information.....	143
Return Material Authorization Policy.....	145
Optional Extended Warranty	146

Table of Figures

Figure 1 - Part Number Guide	4
Figure 2 - Mechanical Outline - Front View	8
Figure 3 - Mechanical Outline - Side View	8
Figure 4 - Mechanical Outline - Rear View.....	9
Figure 5 - Mechanical Outline - Top View	9
Figure 6 - Temperature Derating Curve – “F” Option.....	11
Figure 7 - Temperature Derating Curve – “B” Option.....	11
Figure 8 - DC Input Voltage Derating Curve.....	12
Figure 9 - AC Line Voltage Derating	13
Figure 10 - Elevation Derating Curves – “F” option	14
Figure 11 - Elevation Derating Curves – “B” option.....	14
Figure 12 - Shipping Contents.....	16
Figure 13 - Interface Identification and Location.....	18
Figure 14 - DC Terminal Block Connections.....	20
Figure 15 - AC Terminal Block Connections	22
Figure 16 - Low Voltage I/O Connections	22
Figure 17 - Visual Indicators.....	23
Figure 18 - Modbus Serial Interface Wiring.....	25
Figure 19 - Discrete Input Interface	25
Figure 20 - Discrete Output Interface	26
Figure 21 - System Block Diagram.....	27
Figure 22 - Grid Tie Mode System Block Diagram.....	28
Figure 23 - Volt/Watt Configuration.....	31
Figure 24 - Frequency/Watt Configuration.....	33
Figure 25 - Volt/VAR Configuration	38
Figure 26 - Watt/VAR Configuration.....	40
Figure 27 - Ride Through Cessation and Trip Curves	43
Figure 28 - Voltage Ride Through IEEE 1547-2018 Configuration	45
Figure 29 - Frequency Ride Through IEEE 1547-2018 Configuration.....	47
Figure 30 - Island Mode Capable System Block Diagram.....	48
Figure 31 - PCS Control State Machine	53
Figure 32 - RTU Message Frame (PDU) Format	85
Figure 33 - Oztek Power Studio™ GUI	140

Table of Tables

Table 1 - Revision History.....	1
Table 2 - Document Acronyms.....	2
Table 3 - Compatible Compression Lugs (DC).....	19
Table 4 - Compatible Compression Lugs (AC).....	21
Table 5 - LED Functions - Normal Operation	23
Table 6 - LED Functions - Bootloader Operation	23
Table 7 - I/O D-Sub 15 Pinout	24
Table 8 - Alarm Output Mask Registers	27
Table 9 - Frequency-Watt Control Equations	34
Table 10 - IEEE 1547-2018 Default L/HVRT Trip Settings.....	44
Table 11 - IEEE 1547-2018 Default L/HVRT Trip Settings	46
Table 12 - Data Logging Parameters	68
Table 13 - Fault Log Header Data Description	70
Table 14 - Fault Log Buffer Organization	70
Table 15 - User Log Variable Selection Bit Assignment	71
Table 16 - User Log Trigger Configuration Example.....	73
Table 17 - User Log Header Data Description.....	74
Table 18 - User Log Buffer Organization.....	74
Table 19 - Fault History Index Assignment	75
Table 20 - Fault Time Stamp Buffer Arrangement.....	76
Table 21 - Operating Time Parameter Log.....	77
Table 22 - Min/Max Parameter Log.....	81
Table 23 - Modbus Interface Specifications.....	83
Table 24 - Modbus Exception Codes.....	87
Table 25 - SunSpec Models.....	91
Table 26 - SunSpec Curve-Based Models.....	95

Table 1 - Revision History

Rev	Date	Description of Change	Author
A	2/8/2023	<ul style="list-style-type: none"> Initial Release 	Hodgdon
B	5/11/2023	<ul style="list-style-type: none"> Added support to specify VARs for Fixed VAR, Volt-VAR, and Watt-VAR modes as % of Max Watts, VARs, or VA (see REG 40347, 40394, 40424, 41643, 41667) Added SunSpec certification 	Hodgdon
C	8/9/2023	<ul style="list-style-type: none"> Fixed Modbus message CRC byte order in Section 10.4 tables 	Hodgdon
D	10/3/2023	<ul style="list-style-type: none"> Updated Section 6.2.4.3 (Volt-VAR) to state that for non-unity static Vref values, the voltage points (% of V_{nom}) must be manually adjusted based on changes in the expected Vref Changed default value for REG 41817 to 100% (not 44%) 	Hodgdon
E	11/16/2023	<ul style="list-style-type: none"> Corrected REG 40101 description in Section 11.3.4 	Hodgdon
F	1/23/2024	<ul style="list-style-type: none"> Changed the values for the Rated AC Voltage Maximum/Minimum registers (REG 40255/40256) 	Hodgdon
G	2/15/2024	<ul style="list-style-type: none"> Added voltage ratings for RS485 signals 	Hodgdon
H	3/4/2024	<ul style="list-style-type: none"> Adding Authorization To Mark certification 	Hodgdon
J	4/15/2024	<ul style="list-style-type: none"> Fixed Data Type for Volt-VAR Curve 2: Response Time in Section 11.3.8 	Hodgdon
K	4/18/2024	<ul style="list-style-type: none"> Changed RS485 signal names from A/B to +/- for clarity 	Hodgdon
L	5/20/2024	<ul style="list-style-type: none"> Removed 'auto clear' comment from REG 41742 and 41743 	Hodgdon
M	5/30/2024	<ul style="list-style-type: none"> Added configuration caution to Watt/VAR section 6.2.4.4 	Hodgdon
N	7/31/2024	<ul style="list-style-type: none"> Installation of terminal block cover is added to sections 4.2.1 and 4.2.2 	Avkshtol

1. Introduction

This document is intended to provide detailed specifications and instructions on how to properly install and operate an OZpcs-RS40 Energy Storage Power Conversion System (PCS). To provide for safe installation and operation of the equipment, please read the safety guidelines at the beginning of this manual and follow the procedures outlined before connecting power to the PCS.

1.1 Referenced Documents

Author	Document
Oztek	OzPCS-RS40 Seamless Transfer System Configuration (AN-0003)
Oztek	Oztek Power Studio™ User's Manual (UM-0052)
Oztek	TMS28x CAN Bootloader (FS-0057)
Modbus.org	Modbus Over Serial Line v1.02
Modbus.org	Modbus Application Protocol Specification v1.1b
SunSpec Alliance	SunSpec Technology Overview 12040 v1.4
SunSpec Alliance	SunSpec Device Information Model Specification V1.0
SunSpec Alliance	SunSpec DER Information Model Specification V1.0
SunSpec Alliance	SunSpec_Information_Model_Reference_20211209.xls

1.2 General Information

Throughout this document, acronyms may be employed for brevity and readability. These are summarized in Table 2.

Table 2 - Document Acronyms

Acronym	Full Text Equivalent
AC	Alternating Current
AFE	Active Front End
AWG	American Wire Gauge
CEC	California Energy Commission
DC	Direct Current
ESD	Electrostatic Discharge
GUI	Graphical User Interface
HV	High Voltage
HVRT	High Voltage Ride Through
HFRT	High Frequency Ride Through
I/O	Input/Output
LVRT	Low Voltage Ride Through
LFRT	Low Frequency Ride Through

Acronym	Full Text Equivalent
NOP	No Operation
OOT	Out of Tolerance
PCC	Point of Common Coupling
PCS	Power Conversion System
RH	Relative Humidity
RMS	Root Mean Square
RTC	Real Time Clock
RTU	Remote Terminal Unit
STS	Static Transfer Switch
THD	Total Harmonic Distortion

1.3 General Safety



DANGER

Power inverters are typically connected to hazardous voltages. When servicing an inverter, there may be exposed terminals at or above line potential, as well as residual charge in place for some time after the removal of the input source. Extreme care should be taken to protect against shock.

- 1. Before startup, observe the warnings and safety instructions provided throughout this manual. All power terminals should be considered at utility AC or high DC potential unless verified to be otherwise. These voltages are extremely dangerous and may cause death or severe injury if contacted.***
- 2. All power terminals should be considered live with the application of input voltage regardless of operating mode of the load.***
- 3. Do not make any connections when the PCS is connected to its power source.***
- 4. Never work on the PCS, power cables, or load when input power is applied.***



WARNING

- 1. Do not make any insulation or voltage withstand tests on the PCS.**
- 2. Before servicing the unit, always ensure by measuring with a multimeter that**
 - a. There is no voltage between the AC terminals (A, B, & C) and chassis ground.**
 - b. There is no voltage between the DC terminals (+ & -), nor between either DC terminal and chassis ground.**

**CAUTION**

1. The PCS operates on several electrical reference points, whether these be earth ground, communication ground, signal ground, etc. Proper system design regarding equipotential bonding must be employed so that all simultaneously accessible conductive parts are electrically connected to prevent hazardous voltages appearing between them. This is accomplished by a proper factory grounding.
2. Ensure sufficient cooling for safe operation of the PCS.
3. The PCS is not field repairable. Never attempt to repair a malfunctioning unit; contact Oztek for a replacement.
4. Each PCS is sealed with a warranty void sticker across the top cover which will tear if the cover is removed. A torn warranty void sticker shall be interpreted as unauthorized access to the internal contents of the PCS, in violation of warranty terms, thereby terminating any remaining warranty otherwise in effect.

1.4 Orderable Part Numbers

The OZpcs-RS40 SB is currently available with two airflow options, either front to back, or back to front. The options are identified using the orderable part number shown below. The standard (and recommended) configuration is the front-to-back airflow option as this provides better cooling for the PCS's internal components. The back-to-front model is available for end systems that are constrained to airflow in this direction, however this comes at the expense of reduced operating temperature range (see section 2.7 for details).

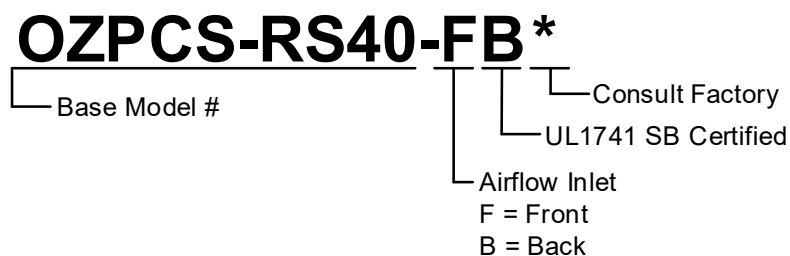

Figure 1 - Part Number Guide

The OZpcs-RS40 ships with mounting brackets used to attach the unit to the front of the rack (see Section 3). These brackets are available in two versions – one compatible with US Customary mounting hardware (10-32) and one for metric mounting hardware (M6). When placing your order, please specify which brackets (US Customary or metric) should be included. Additional mounting bracket options are also available – contact Oztek for more details.

2. Specifications

2.1 Reliability

Operational Life	20 Years at 25°C, 33% full load duty cycle
Service Interval	No field service required.

2.2 Electrical Specifications

DC Input	
DC Input Voltage Range	330 to 820 V, Derated below 550 V, see section 0
DC Input Current	75 A maximum (operating)
Maximum Overload DC Input Current	The DC input does not include fuse protection. It is expected that the customer provides a means to limit the current to 100 Amps
DC Input Impedance	750k Ohm minimum across DC inputs
Max Input Short Circuit Current	107 A
Max Backfeed Current	n/a, no backfeed current from AC to DC terminals
AC Interface (Utility-interactive and Stand-alone)	
Power Rating	±40 kW, ±40 kVAR, ±40 kVA @ 480 VAC
Power Factor	0 to 1 leading or lagging
Number of Phases	3-wire / 4-wire, Configurable
Nominal Grid Frequency	50 Hz / 60 Hz, Configurable
Operating Voltage	208 to 480 V _{RMS} , Configurable
Rated AC Output Current	50 A _{RMS}
Max AC Output Over Current Protection	88 A _{RMS}
Max AC Fault Current	208 A
Max AC Fault Current Duration	2.24 msec
Phase Voltage Imbalance	<10%
Max AC Connect Voltage	585 V _{RMS} (line to line): The PCS will disconnect from the AC interface at voltages greater than this value.
Max Operating Frequency	90 Hz
Min Operating Frequency	30 Hz
AC Interface (Utility-interactive)	
PQ Power Accuracy	±3% of full scale
PQ Command Resolution	1% rated
PQ Command Slew Rate	400 kVA/s max (configurable)
Output Current Distortion	< 5% TDD per IEEE 519 operating conditions < 3% Max at rated power

Active Ride Through V_{MAX}	535 V_{RMS} (line-to-line), 576 V_{RMS} (isolated 3-wire operation, see REG 41829 – AC Connection Type): Regions in the High Voltage Ride Through Momentary Cessation curve that exceed this voltage will be forced to this value.
AC Interface (Stand-alone)	
Max Operating Voltage	576 V_{RMS}
Voltage Regulation ¹	< 10% of Voltage Rating, 0-100% load - per UL1741 45.2.1
Frequency Regulation ¹	< 1 Hz of Frequency Rating - per UL1741 45.2.1
Max Black Start Voltage ²	10 V_{RMS}
Output Voltage Distortion	< 1% Max THD operating at 100% resistive load
Max Current Imbalance	25 A_{RMS}
General	
CEC Efficiency	96.7% (OZPCS-RS40-BB*) 96.2% (OZPCS-RS40-FB*)
Peak Efficiency	97.5% (OZPCS-RS40-BB*) 97.2% (OZPCS-RS40-FB*)
Standby Power	29W, Power draw from DC input when in Standby state
Inrush Current	< 1A, internal soft start provided
Power On Response Time	<ul style="list-style-type: none"> • 3.5 sec: time from Bias Enable input asserted to when PCS transitions to DISABLED state • 6 sec: time to transition from DISABLED to STANDBY state from receipt of “Start” serial command, (worst case, cold start with maximum DC input voltage) • 2 ms: time to transition from STANDBY to ONLINE state from receipt of “Exit Standby” serial command
Discrete Outputs	
Voltage (max)	32 V_{DC}
Current (max)	5 mA
Discrete Inputs	
Voltage (min) – ESTOP, DIN	5 V_{DC}
Voltage (min) – BIAS ON/OFF	19 V_{DC}
Voltage (max)	32 V_{DC}
Current (max)	10 mA
RS-485 (“+” or “-” signal to RS485_GND)	
Voltage (min)	-7 V_{DC}
Voltage (max)	12 V_{DC}

¹ Regulated voltage and frequency are affected by Grid Forming droop control and virtual impedance settings. For true stand-alone operation, these can be disabled (see section 6.3.4).

² The island voltage must be below this value for the PCS to perform a black start.

2.3 Environmental Specifications (Indoor use)

Operating Temperature Range	“F” Option, Air Flow front to back: -5 to 60 °C “B” Option, Air Flow back to front: -5 to 50 °C <i>Customer derating required to meet warranty and life specifications (see Section 2.7 for details)</i>
Storage Temperature Range	-20 to 60 °C
Operating Humidity Range	30 – 90% RH (no condensation)
Storage Humidity Range	10 - 95% RH (no condensation)
Operating Altitude	1,000 m No Derating, >1,000 m Derated
Pollution Degree	2 (IEC 1010-1)
Ingress Protection Rating	IP20
Acoustic Noise	75 dBA Max in all directions, horizontal distance of 3ft

2.4 Mechanical Specifications

Cooling	Forced air cooled by internal fan.
Weight	97 lb
Dimensions	19” rack, 2.5U, see section 0
Vibration	MIL-810E, method 514.4 test condition I-3.3.1
Shock	Less than 20G, half sine, 11mS, unpacked
Seismic	1G seismic zone (IEEE 693 High Seismic) with seismic spectra of 0.5G

2.5 Accuracies

The following accuracies apply to both 480 V_{RMS} and 208 V_{RMS} operation:

Parameter	Maximum Error
AC Voltage	±1% of 480 V _{RMS} , or ±4.8 V _{RMS}
DC Voltage	±2% of 820 V, or ±16.4 V
AC Current	±3% of 50 A _{RMS} , or ±1.5 A _{RMS}
DC Current	±3% of 75 A, or ±2.25 A
Power	±3% of 40 kW/kVAR, or ±1.2 kW/kVAR
Power Factor	±5%
Frequency	±0.01 Hz
Time	±0.05 sec

2.6 Mechanical Dimensions

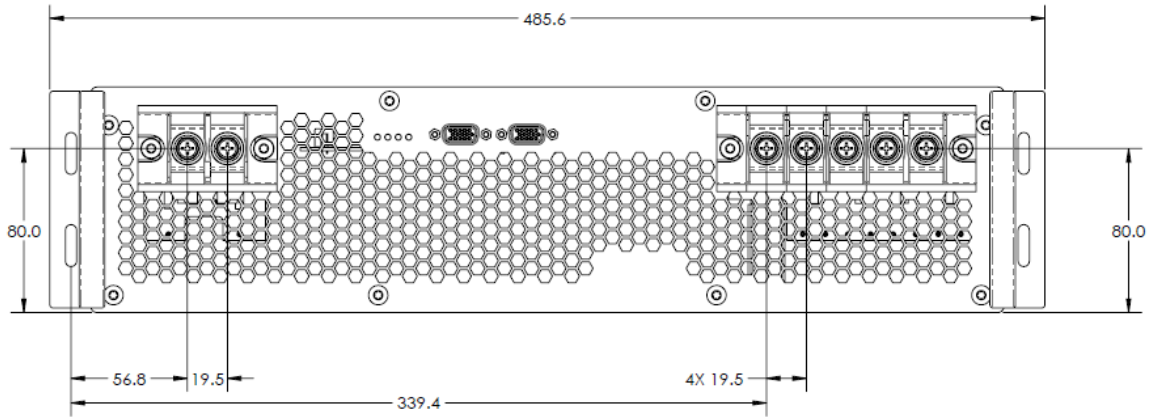

Figure 2 - Mechanical Outline - Front View

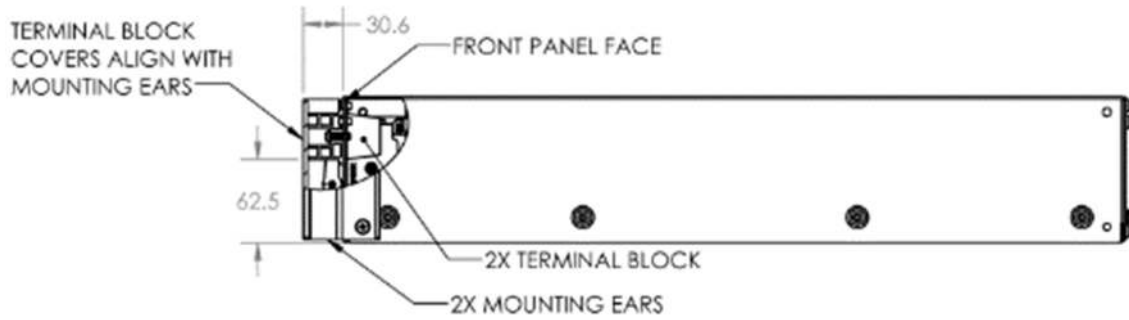

Figure 3 - Mechanical Outline - Side View

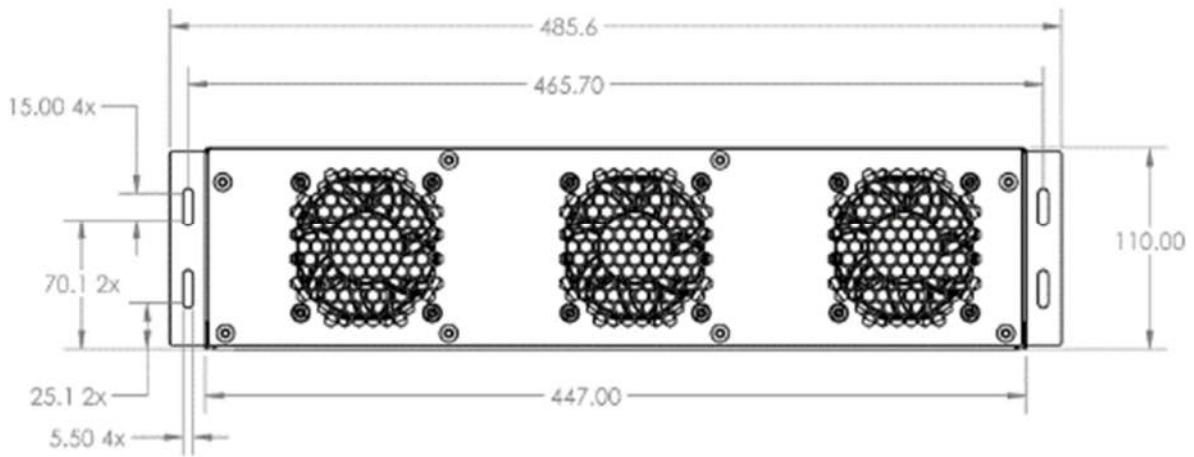

Figure 4 - Mechanical Outline - Rear View

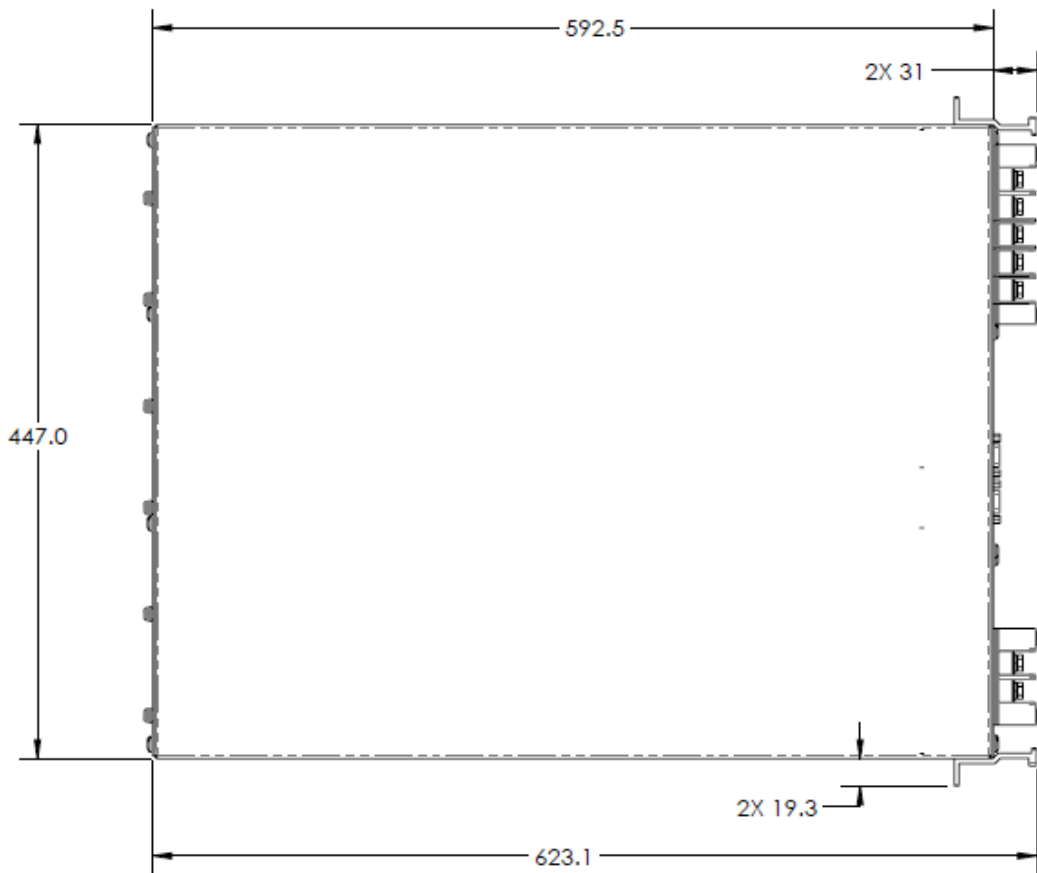

Figure 5 - Mechanical Outline - Top View

2.7 Temperature Based Power Derating

The PCS can be ordered with two different fan orientations: one for front-to-back airflow and one for back-to-front. The recommended configuration is the front-to-back airflow option as this provides better cooling for the PCS's internal components. The back-to-front model is available for end systems that are constrained to airflow in this direction, however this comes at the expense of reduced operating temperature range.

The figures below show the continuous and peak operating temperature regions for the different PCS fan configurations. The green shaded regions represent the continuous safe operating zone. PCS operation should be limited to this region to meet rated life and not affect the warranty period.

The yellow shaded region represents the intermittent safe operating zone. The PCS may be operated in this region for brief durations. The warranty period is not affected if the total time spent operating in this region is kept below 120 hours. Each additional hour of operation in this zone that exceeds 120 hours will reduce the warranty coverage length by one month.

The red shaded region represents the over-temperature zone. The PCS does not prohibit operation in this zone, but the unit may trip off to protect itself based on its internal over-temperature limits (internal air temperature of 70°C or power device heatsink temperature of 100°C). The end application must be configured to avoid operation in this zone. Continuous operation in this zone will void the warranty.



CAUTION

Operating the PCS for longer than 120 hours in the yellow regions shown below will shorten the product warranty as described above. Continuously operating the PCS in the red regions shown below will void the product warranty.

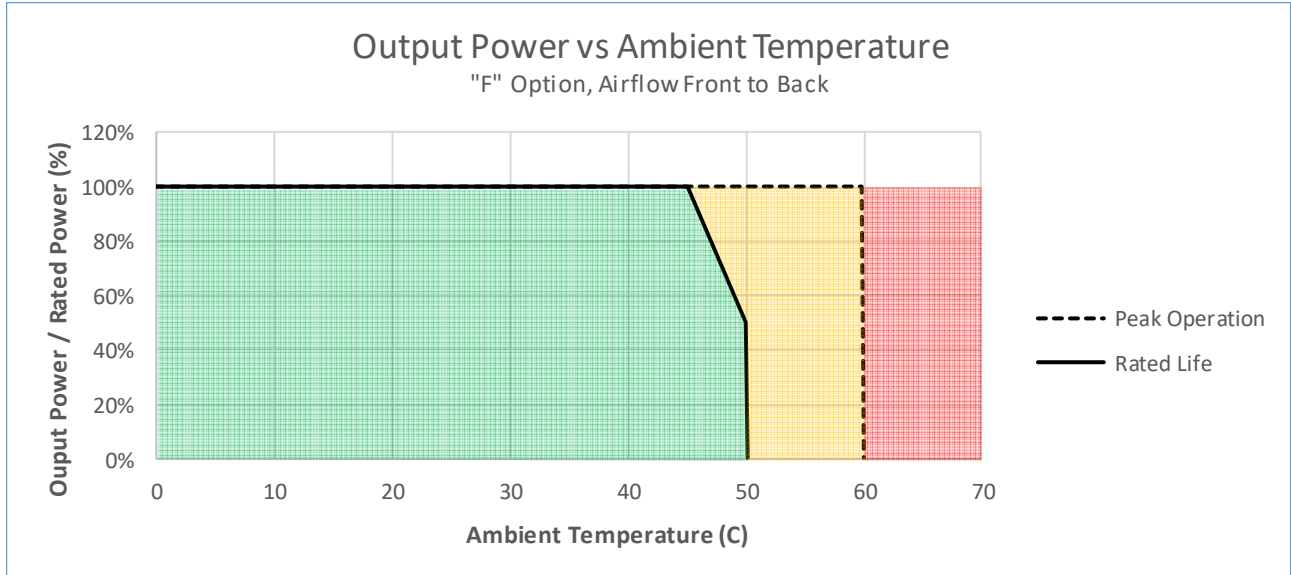

Figure 6 - Temperature Derating Curve – “F” Option

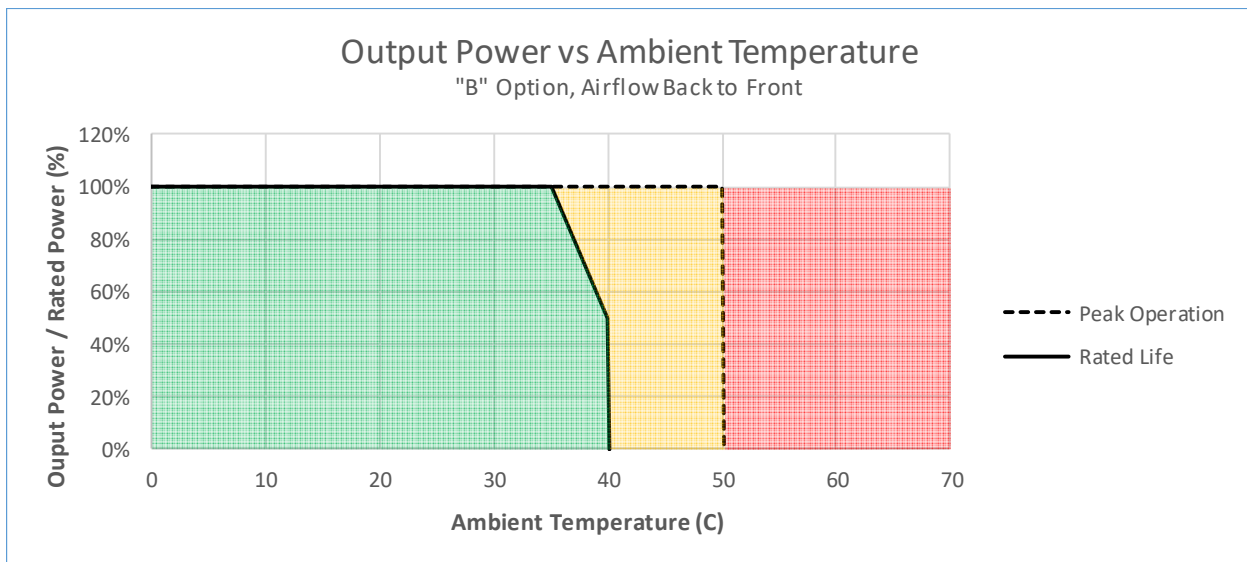

Figure 7 - Temperature Derating Curve – “B” Option

The PCS monitors the air temperature inside the enclosure using a sensor located immediately behind the front panel. This is referred to as the “cabinet temperature” throughout the rest of this document. Accumulated operating time across various temperature ranges is recorded as described in the Datalogging section of this document (Section 9.3.1). For “F” option units with front-to-back airflow, the measured air temperature is the inlet air and will match the external ambient temperature.

For “B” option units with back-to-front airflow, the internal air temperature is the outlet air, which will be greater than the external ambient temperature based on operating power levels.

In general, the temperature rise through the unit is less than 10°C up to 50% power and less than 20°C when operating between 50% and rated power. For the purpose of determining external ambient temperature using the data log measurements, a 10°C rise is assumed for 50% power or less, and a 20°C rise is assumed for greater than 50% power.

2.8 DC Input Voltage Based Power Derating

The chart below illustrates the power derating at low DC input voltages based on the maximum DC current rating. Note that the user may lower the **Maximum DC Charge/Discharge Current** limits (**REG 41748/41749**) from the maximum rated value, in which case the power derating will occur at higher DC input voltages.

When operating in Grid Tie mode, the PCS will automatically limit the AC power based on the derating curve and will assert the **DC Power Limit** warning flag if the user's power command is limited to a lower value.

When operating in Grid Forming mode, the PCS does not enforce the DC power derating curve. In this mode, it is the user's responsibility to keep the load power below the available power for a given DC input voltage and DC current limit value. Failure to do so may result in DC over current faults. If the DC input voltage and programmed current limit values are such that the PCS will be unable to provide the specified rated power, the **DC Power Limit** warning flag will be set to indicate that full power is not available.

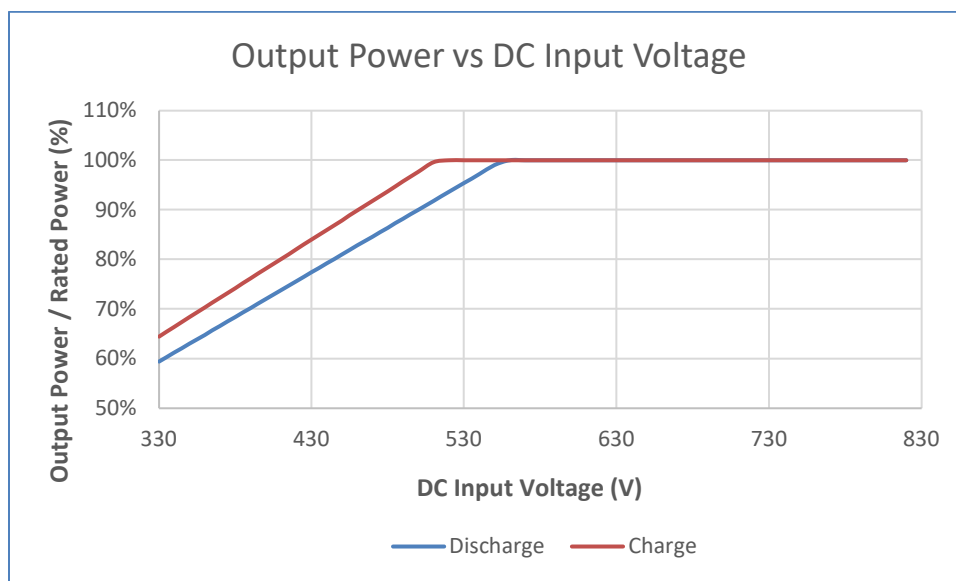

Figure 8 - DC Input Voltage Derating Curve

2.9 AC Voltage Based Power Derating

The chart below illustrates the power derating at low AC line voltages based on the maximum AC current rating. When operating in Grid Tie mode, the PCS will automatically limit the AC power based on the derating curve and will assert the **AC Current Limit** warning flag whenever the commanded power is being limited to a lower value as a result of this current limit.

When operating in Grid Forming mode, the PCS does not enforce the AC power derating curve. In this mode, it is the user's responsibility to keep the load power below the available power for the desired range of acceptable AC line voltages. Failure to do so may result in AC over current faults.

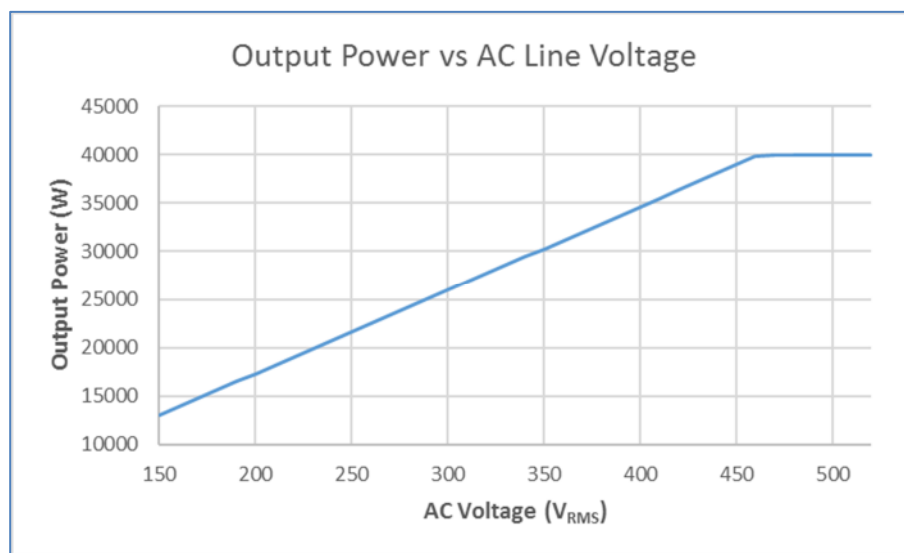

Figure 9 - AC Line Voltage Derating

2.10 Elevation Based Power Derating

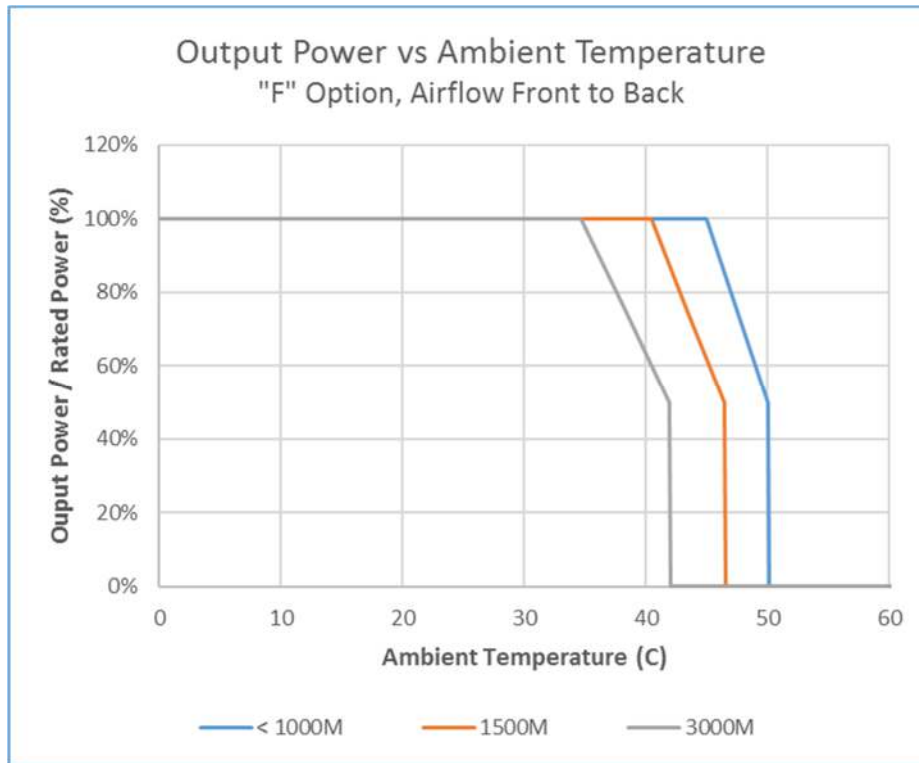

Figure 10 - Elevation Derating Curves – “F” option

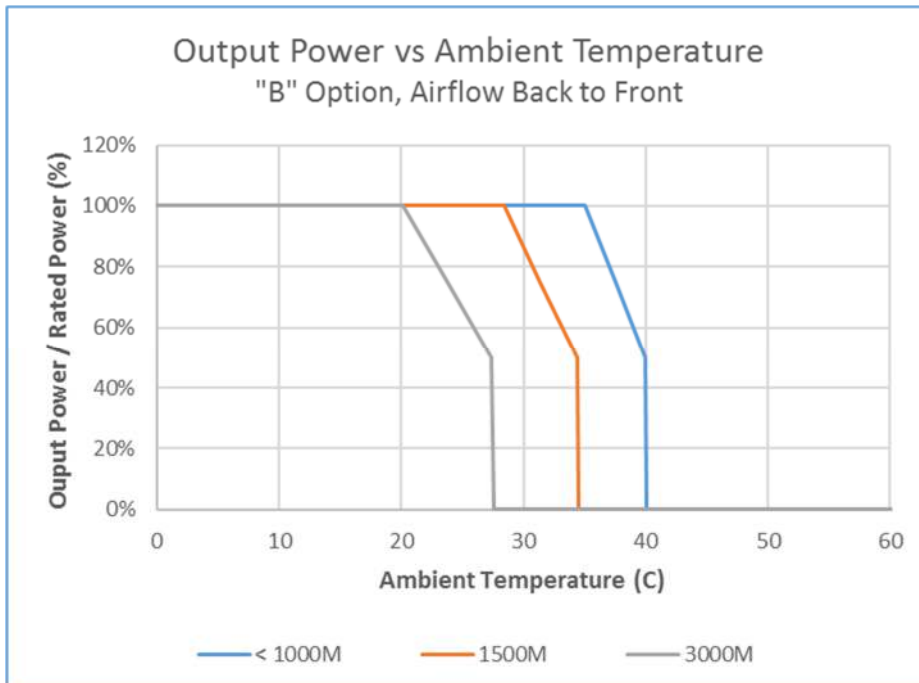

Figure 11 - Elevation Derating Curves – “B” option

2.11 Maintenance

The PCS has been designed to require no maintenance over its operating life.

2.12 Regulatory Specifications

2.12.1 Listings (See Appendix A)

1.	UL1741	Inverters, Converters, Controllers and Interconnection System Equipment for Use with Distributed Energy Resources, Edition 3, Including Supplement SA and SB and CA Rule 21
3.	CSA C22.2#017	Safety Requirements for Electrical Equipment for Measurement, Control, and Laboratory Use.
4.	IEEE 1547-2018	Standard for Interconnection and Interoperability of Distributed Resources with Associated Electric Power Systems Interfaces
5.	CE	Low Voltage Directive per IEC 62477-1
6.	CE	EMC Directive per EN61000-6-4 (emissions), EN61000-6-2 (immunity)
7.	SunSpec	SunSpec Modbus for 1547, including information models 1, 17, 701, 702, 703, 704, 705, 706, 707, 708, 709, 710, 711, 712, 714, 715
8.	California Energy Comm.	CEC Listed Grid Support Inverter

2.12.2 Compliance

This product is designed to comply with the following standards:

1.	IEEE 519	Recommended Practices and Requirements for Harmonic Control in Electrical Power Systems
2.	IPC9592	Performance Parameters for Power Conversion Devices (for components derating and general design guidelines)

3. Unpacking and Inspection

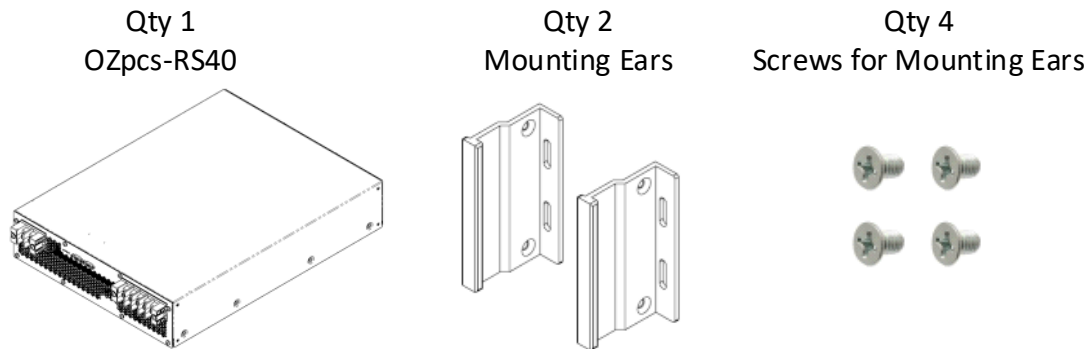

Figure 12 - Shipping Contents



CAUTION

Mechanical lift is strongly recommended. Product weight exceeds limits for individual lift. Team lift is mandatory for any manual movement of the unit before or after unpackaging.

Notice: *Retain the packaging material!*

Proper packaging, including internal cushioning and palletization, is required to maintain warranty coverage on any unit returning to Oztek.

1. Using the provided packing list, verify that the model received corresponds to that ordered and inspect the packaging for any signs of shipping damage. Immediately seek assistance from the freight carrier for any visible signs that the packaging or product has been damaged. If it is necessary to send the OZpcs-RS40 back, use the original packaging.
2. The PCS is a sensitive electronic device. While it has been designed to mitigate risks of ESD damage under normal circumstances, care should be taken not to handle electrical interfaces unnecessarily.
3. Use the enclosed nylon handling straps to hoist the unit out of the shipping container. These straps should be retained and used for all necessary hoisting until the unit has been installed into its system mounting location.

4. Use the four provided Phillips head screws to attach the two mounting ears. Do not exceed 1.8 Nm (16 in-lb) when installing the screws. Note that the mounting ears can be installed at the front panel, where the terminal blocks are located, or at the rear panel, where the fans are situated. The unused mounting holes can be ignored, as they do not impact mechanical integrity of the enclosure.
5. User supplied bolts which penetrate the enclosure beyond 7mm will void the product warranty. Oztek strongly recommends using the supplied hardware to install rack support brackets and mounting ears.

**CAUTION**

Do not carry or lift the OZpcs-RS40 by the mounting ears. The mounting ears are intended as pull handles to slide the unit into or out of a rack. Attempting to lift or carry the unit with these handles may result in injury to the handler and damage to the unit.

4. Installation

4.1 Mechanical

1. Using the lifting straps in conjunction with team lift or mechanical lift best practices, raise the unit to the level at which it is to be installed into the rack.
2. Gently slide the unit onto the rack shelf/rails until the mounting ears contact the rack frame and the ear slots align with the holes in the frame.

**CAUTION**

The OZpcs-RS40 is not intended to be supported by the mounting ears. The unit must be installed on rails or a shelf to support its weight.

3. Using rack hardware (not provided), secure each mounting ear in two places to 3.4 Nm (30 in-lb), or to the torque value recommended by the rack provider, if specified.

4. Ensure that adequate spacing is provided from both the rear and front panels of the unit such that ventilation airflow is not obstructed. Oztek requires 40 mm (1.6") minimum clearance front and back, with greater than 50 mm (2.0") recommended.

4.2 Electrical



WARNING

All electrical installations must be done in accordance with the local and National Electrical Code® ANSI/NFPA 70 or the Canadian Electrical Code® CSA C22.1. This document does not and is not intended to replace any local, state, provincial, federal or national laws, regulation or codes applicable to the installation and use of the PCS, including without limitation applicable electrical safety codes. All installations must conform with the laws, regulations, codes and standards applicable in the jurisdiction of installation. Oztek assumes no responsibility for the compliance or noncompliance with such laws or codes in connection with the installation of the PCS.



CAUTION

Do Not Remove Panels or Cover. No user serviceable parts inside.

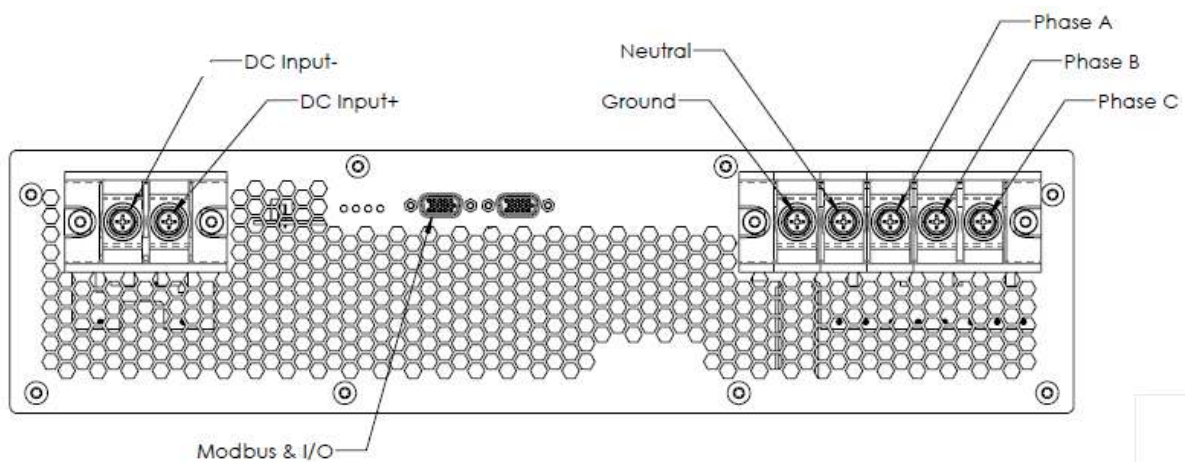

Figure 13 - Interface Identification and Location

4.2.1 DC Connection



DANGER

***High voltage may cause severe personal injury or death.
Avoid contact with electrical terminals.
De-Energize all sources before servicing.***



CAUTION

-The OZpcs-RS40 does not include overcurrent protection on the DC input. The customer is required to provide adequate overcurrent protection external to the PCS.



CAUTION

The DC inputs are intended to float and must not be referenced to earth ground. Referencing either DC terminal to ground will void the warranty and may cause permanent damage to the OZpcs-RS40.

1. For all DC cable connections, use a minimum 4 AWG copper wire that is designed for +90 °C (+194 °F).

Notice: Ambient Temperature

The higher the ambient temperature the higher the power losses. Use cables having larger cross-sections in installations with high ambient temperatures.

2. Connections can be made using wire and compression lugs. See Table 3 for a list of compatible compression lugs.

Table 3 - Compatible Compression Lugs (DC)

Wire Size	Manufacturer	P/N
000	Panduit	LCAN3/0-14-X
00	Panduit	LCAN2/0-14-X

Wire Size	Manufacturer	P/N
0	Panduit	LCAN1/0-14-X
1	Panduit	LCAN1-14-E
2	Panduit	LCAN2-14-Q
3, 4	Panduit	LCAN4-14-L

- Turn off the DC source and secure against turning on again.
- Remove the plastic cover of DC terminal block which is supplied with the product.
- Connect the negative and positive cables to the DC terminal block as shown in Figure 14.
- Connections should be tightened to a specified torque of 2.8 Nm (25 in-lb) +/- 5%.
- After the DC connections are tightened, the manufacturer-supplied cover of the DC terminal block must be re-installed.

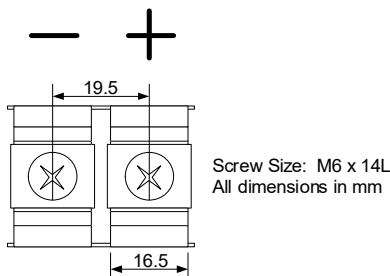

Figure 14 - DC Terminal Block Connections

4.2.2 AC Connection



DANGER

***High voltage may cause severe personal injury or death.
Avoid contact with electrical terminals.
De-Energize all sources before servicing.***

**CAUTION**

The OZpcs-RS40 does not include overcurrent protection on the AC input. The customer is required to provide adequate external branch level protection. The following AC branch circuit current ratings are recommended:

One unit 70A
Two units 150A
Three units 200A

1. For all AC cable connections, use a minimum 4 AWG copper wire that is designed for +90 °C (+194 °F).

Notice: Ambient Temperature

The higher the ambient temperature the higher the power losses. Use cables having larger cross-sections in installations with high ambient temperatures.

2. Connections can be made using wire and compression lugs. See Table 4 for a list of compatible compression lugs.

Table 4 - Compatible Compression Lugs (AC)

Wire Size	Manufacturer	P/N
000	Panduit	LCAN3/0-14-X
00	Panduit	LCAN2/0-14-X
0	Panduit	LCAN1/0-14-X
1	Panduit	LCAN1-14-E
2	Panduit	LCAN2-14-Q
3, 4	Panduit	LCAN4-14-L

3. Turn off the AC source and secure against turning on again.
4. Remove the plastic cover of AC terminal block which is supplied with the product.
5. Connect the ground cable as well as the three utility phase cables to the AC terminal block as shown in Figure 15.
6. The neutral connection (N) is provided for 4-wire grid-forming or standalone operation – this terminal should be left unconnected for grid-tie only applications. When the neutral connection is used, **REG 41829 – AC Connection Type** must be set to '1' to indicate 4-wire operation.
7. Connections should be tightened to a specified torque of 2.8 Nm (25 in-lb) +/- 5%.

- After the AC connections are tightened, the manufacturer-supplied cover of the AC terminal block must be re-installed.

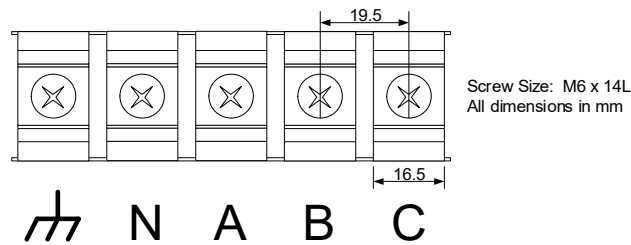

Figure 15 - AC Terminal Block Connections

4.2.3 Low Voltage I/O

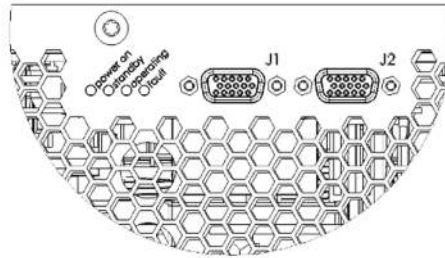

Figure 16 - Low Voltage I/O Connections

All isolated, low voltage I/O signals are provided on a standard High Density, D-Sub, 15-pin, female connector (J1). A second connector (J2) with an identical pin-out is provided to allow for daisy-chaining paralleled units, as well as terminating the Modbus data link. An example of a mating connector part number is given below:

Manufacturer: Amphenol

Manufacturer p/n: 10090769-P154ALF

- Install the primary interface cable to either connector J1 or J2. Tighten the mounting screws to no more than 0.6Nm (5 in-lb).
- If the unit is to be daisy-chained with other units in parallel, secure a second I/O cable to the unused connector, J1 or J2. Tighten the mounting screws to no more than 0.6Nm (5 in-lb).
- When using a single unit or if the unit is the last in a string of daisy-chained units, attach a terminating jumper dongle to the unused connector, J1 or J2. Tighten the mounting screws to no more than 0.6Nm (5 in-lb). The dongle should jumper pins 4 to 5 and pins 14 to 15 to provide termination for the Modbus communications link.

4.2.4 Configuration

The OZpcs-RS40 is shipped from the factory configured for a nominal line voltage of 480 V_{AC} and a frequency of 60 Hz. If the OZpcs-RS40 is intended to be used with line voltages other than 480 V_{AC}, 60Hz, the user must configure **REG 40254 – AC Voltage Nominal Rating** and **REG 41818 – Nominal AC Frequency Setting** for the proper conditions.

Likewise, there are many user configurable parameters that determine the operating behavior of the PCS. It is the responsibility of the user to review this manual and the register set to ensure the PCS is configured appropriately for their application.

5. Interface

5.1 Visual Indicators

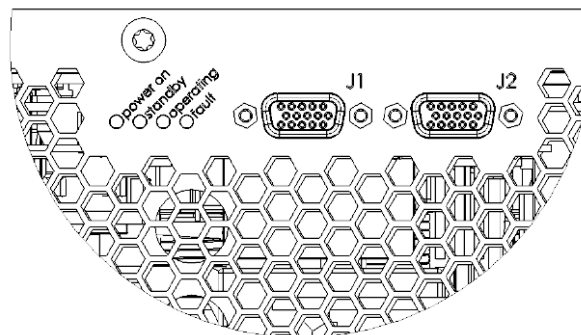

Figure 17 - Visual Indicators

The PCS includes 4 LED's on the front panel to indicate operating status. Table 5 defines the meaning of each LED for normal operation while Table 6 defines their meaning when the bootloader is running during firmware updates.

Table 5 - LED Functions - Normal Operation

Color	Label	Location	Meaning
Green	POWER ON	Front Panel	On Solid: Bias Supply is Operating
Yellow	STANDBY	Front Panel	On Solid: System is in Standby State
Yellow	OPERATING	Front Panel	On Solid: System is processing power
Red	FAULT	Front Panel	On Solid: System is Faulted

Table 6 - LED Functions - Bootloader Operation

Color	Label	Location	Meaning
Green	POWER ON	Front Panel	Blinking: Bootloader is running
Yellow	STANDBY	Front Panel	On Solid: PCS is connected to the Host

Color	Label	Location	Meaning
Yellow	OPERATING	Front Panel	Rapid Blink: Data exchange with Host in progress
Red	FAULT	Front Panel	On Solid: Bootloader error, e.g. CRC error

5.2 Low Voltage I/O

All isolated, low voltage I/O signals are provided on two standard High Density, D-Sub, 15-pin, female connectors. The pinout for the two connectors is provided in the following table.

Table 7 - I/O D-Sub 15 Pinout

Pin #	Name	Description
1	ESTOP_C	Opto-Isolated Emergency Stop - Cathode Input
2	ESTOP_A	Opto-Isolated Emergency Stop - Anode Input
3	DOUT1_C	Opto-Isolated Output #1 – Collector
4	TERM “+”	RS-485 Termination Resistor (“+” connection)
5	RS485 “+”	RS-485 “+” Data Signal
6	DIN_A	Opto-Isolated Island Control Input – Anode Input
7	BIAS_EN_A	Opto-Isolated Bias Enable – Anode Input
8	DOUT2_C	Opto-Isolated Output #2 – Collector
9	DOUT1_E	Opto-Isolated Output #1 – Emitter
10	RS485_GND	Isolated Ground for RS-485 interface
11	DIN_C	Opto-Isolated Island Control Input – Cathode Input
12	BIAS_EN_C	Opto-Isolated Bias Enable – Cathode Input
13	DOUT2_E	Opto-Isolated Output #2 – Emitter
14	TERM “-”	RS-485 Termination Resistor (“-” connection)
15	RS485 “-”	RS-485 “-” Data Signal

5.2.1 Modbus RS-485

The RS-485 interface requires three signals, “+” and “-” data signals and Ground. RS-485 is a multi-drop data bus; i.e. multiple devices can all tie directly onto the same physical signals. For proper signal integrity, the data bus must be terminated at both ends. To allow for easy wiring of paralleled units, two connectors are provided. In addition, an internal terminating resistor is provided.

Figure 18 illustrates how to correctly wire the RS-485 data bus when paralleling multiple devices. Please note the following:

- **All three wires, “+” and “-” signal wires as well as a ground reference, should be connected**
- **The last device on the bus must have its terminating resistor connected by providing a jumper wire between pins 4-5 and 14-15.**



CAUTION

The RS-485 data bus must be terminated for reliable communications. Do NOT terminate every device on the bus, as this will degrade the signals and overload the transceivers. Only the devices physically located at the end of the wires should have termination.

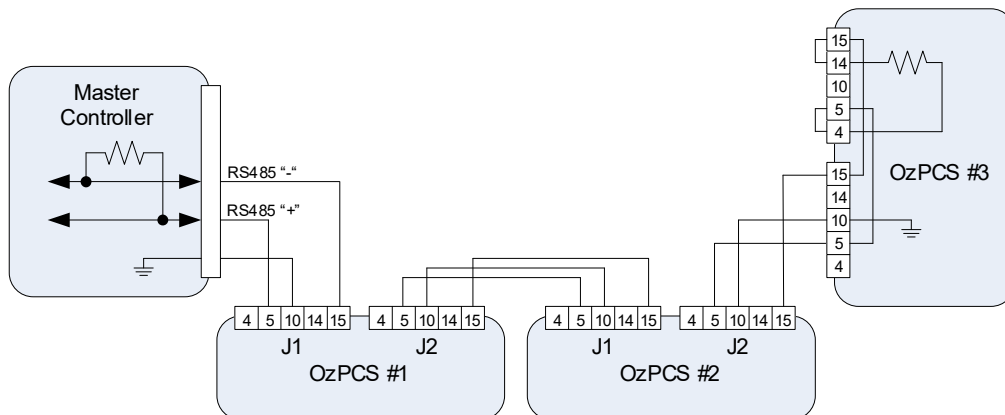

Figure 18 - Modbus Serial Interface Wiring

5.2.2 Inputs

The PCS provides three, opto-isolated, discrete inputs. The Emergency Stop and DIN inputs are designed such that they can be directly driven with voltages from 5 up to 32V_{DC} as illustrated in Figure 19. Note that the Bias Enable input has a slightly different interface and requires a 24V_{DC} input to work.

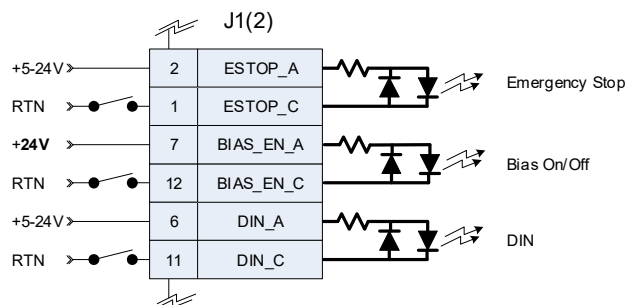

Figure 19 - Discrete Input Interface

5.2.2.1 Emergency Stop

The Emergency Stop (ESTOP) input provides a hardware only enable path. For the PCS to process power, i.e. DC/DC and inverter contactors closed, this input must remain asserted. The signal provides a direct hardware enable path to both the input and output contactors. The PCS will report an ESTOP fault whenever this input isn't asserted,

5.2.2.2 Bias On/Off

The Bias On/Off input is used to enable the PCS's bias supply. As long as this opto-isolated input is asserted by applying 24 V_{DC}, the bias supply remains operating. When the input is deasserted, the bias supply will hold up for approximately 2.5 sec to allow the microprocessor to finish its housekeeping tasks, after which the bias supply is powered off.



CAUTION

The PCS's internal bias supply is generated from the high voltage DC battery input. The user should ensure that the battery voltage remains present while the Bias On/Off input is asserted, as well as for the brief shutdown period after this pin is deasserted. Disconnecting the battery input while Bias On/Off is asserted will cause the internal bias supply to turn off immediately, bypassing any power-down housekeeping tasks, and possibly resulting in the loss of accumulated datalogging information!

5.2.2.3 Island Control Input

The PCS provides a digital input that may be configured for use as an Island Control pin, allowing an external controller to switch between Grid Tie and Grid Forming modes. See **REG 42231 – Island Control Input Pin Configuration** for details on programmable options for this pin. If not used, this pin may be left unconnected.

5.2.3 Outputs

There are two, opto-isolated, discrete status outputs as illustrated in Figure 20. Each of the outputs can be configured to represent a combination of selectable fault, warning, and operational events. The output polarity can be configured using **REG 41891 – Alarm Output Pin Polarity**.

J1(2)	
3	DOUT1_C
9	DOUT1_E
8	DOUT2_C
13	DOUT2_E

Figure 20 - Discrete Output Interface

Each output has several mask registers associated with it, one corresponding to the PCS Fault status, one for PCS Warning status, one for DER Alarm conditions, one for operating state, and one for other miscellaneous events. The table below lists the mask registers along with the corresponding status registers.

Table 8 - Alarm Output Mask Registers

Alarm Output Mask Register		Status Register
41883	Alarm Output 1 – PCS Fault Mask	41758
41885	Alarm Output 1 – PCS Warning Mask	41756
41892	Alarm Output 1 – PCS State Mask	n/a
41896	Alarm Output 1 – Misc. Function Mask	n/a
41901	Alarm Output 1 – DER Alarm Bit Mask	40091
41887	Alarm Output 2 – PCS Fault Mask	41758
41889	Alarm Output 2 – PCS Warning Mask	41756
41894	Alarm Output 2 – PCS State Mask	n/a
41897	Alarm Output 2 – Misc. Function Mask	n/a
41903	Alarm Output 2 – DER Alarm Bit Mask	40091

Setting a bit to “1” in the mask register will enable the corresponding fault, warning, state, or function to drive that output. Setting multiple mask bits to “1” logically OR’s those faults, warnings, states, and functions together.

For example, setting Register 41883 and 41885 to 0xFFFFFFFF enables any PCS fault or warning to drive Alarm Output 1. Similarly, setting Register 41887 and 41889 to 0xFFFFFFFF enables any PCS fault or warning to drive Alarm Output 2.

6. Operation

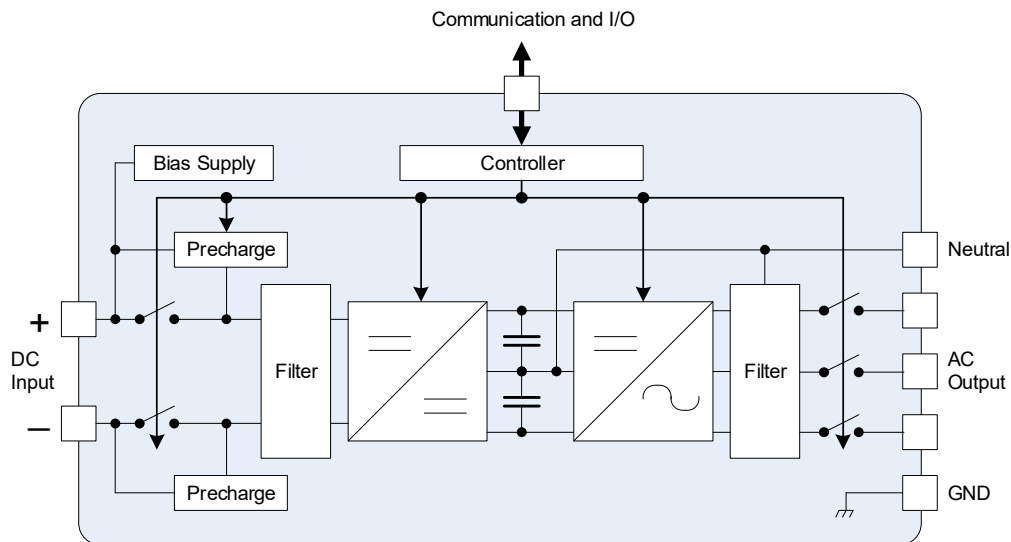

Figure 21 - System Block Diagram

6.1 Bias Power

The PCS incorporates an internal bias supply that derives the necessary working voltages from the high voltage DC input. The bias supply is controlled with the “Bias On/Off” discrete input. When this input is asserted, the bias supply is enabled and drawing power from the DC input. When the input is deasserted, the bias supply is disabled. Note that it may take up to 2.5 sec to turn off after the signal is deasserted to allow orderly shutdown of the PCS controller.

6.2 Grid Tie Operating Mode

When configured to operate in Grid Tie mode (see **REG 41747** and **REG 41813**), the PCS provides bi-directional, active and reactive (P/Q) power control to the grid. Assuming the grid is present and within specification, the PCS will connect and accept power commands from the user. Multiple PCSs may be operated in parallel, providing a modular solution for higher power applications.

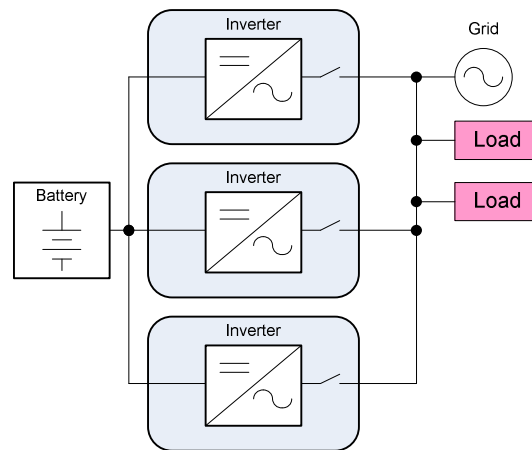

Figure 22 - Grid Tie Mode System Block Diagram

6.2.1 Initiating Grid Tie Operation

When the PCS is first powered up, its internal DC and AC contactors are both open. Prior to operating the PCS, a “Start” command should be sent (**REG 41743 – Set Operation = 1**), instructing the PCS to close these contactors. At this point, if a valid grid voltage and frequency are detected, the PCS will go through an internal pre-charge process to safely bring all internal voltages up to their required levels and then the contactors will be closed. Once connected to the grid, the PCS can be turned on by sending an “Exit Standby” command (**REG 41743 – Set Operation = 3**). When this command is received, the PCS will first wait the random delay specified in **REG 41823 – Initial Turn-On Window**. Once this time has expired, the PCS will turn on and ramp to the last commanded power setpoints at the rate specified in **REG 41824 – Initial Turn-On Ramp Time**. The initial turn-on wait period can be bypassed by setting the turn-on window to zero. Once the output power has finished ramping to the commanded setpoints, any subsequent changes in power commands will cause the PCS to ramp to these values at a

rate specified in **REG 40360 – Active Power Ramp Rate** and **REG 40362 – Reactive Power Ramp Rate**.

A single PCS may be turned on by issuing the above commands to that specific unit's unique Modbus device address (specified in **REG 40069**). Alternatively, multiple PCS's may be turned on at the same time by issuing the above commands to the dedicated Modbus broadcast device address of zero. This assumes that all parallel PCS's are attached to the same physical RS-485 bus.

6.2.2 Enabling Service

When configured for Grid Tie mode, the PCS uses the standard SunSpec “Enter Service” register model to determine if and when the PCS is allowed to operate into the grid (see section 11.3.6 for register details).

When **REG 40294 – Permit Enter Service** is set to a “1”, the PCS may connect to the grid and control active and reactive power. When this register is set to a “0”, the PCS is not allowed to operate into the grid and will instead wait in the **Service Disabled** state with the AC and DC contactors open until service is eventually enabled. Note that this is a non-volatile register and the latest value written will persist between power cycles.

If service is permitted, the grid voltage and frequency must be within the ranges configured in **REG 40295-40299 – Enter Service High/Low Voltage/Frequency Threshold**. If the grid voltage or frequency does not meet this criterion, the PCS will set the **Grid Out of Tolerance (OOT)** warning bit in **REG 41756 – PCS Warning Status**. If the PCS is commanded to turn on when the grid is out of tolerance, it will transition to the **Charge Wait** state and wait for the grid to be within the prescribed limits before turning on.

When enabling service from the **Service Disabled** state, the PCS will remain in this state while the **Grid Out of Tolerance** warning is active (i.e. while the grid voltage and frequency are outside the prescribed limits). Once the grid is within tolerance, the PCS then waits for an additional period determined by **REG 40301 – Enter Service Delay Time**. While the grid remains within tolerance and the PCS is waiting for this fixed delay time, the **Resume – Delay** warning bit will be set in **REG 41756 – PCS Warning Status**. Also, **REG 40307 – Enter Service Delay Time Remaining** can be read to determine how much time is left before the delay timer expires and service is allowed. If the grid voltage or frequency fall outside of the configured thresholds while the delay timer is active, the timer will be reset and the **Resume – Delay** warning will be replaced with the **Grid Out of Tolerance** warning. For the PCS to enable service, the grid must remain within the configured voltage/frequency thresholds for the entirety of the delay time duration.

If the PCS was previously operating prior to service being disabled, or if it has been commanded to operate while in the **Service Disabled** state (see issuing “Start” and “Exit Standby” from previous section), and then service is re-enabled, once the fixed delay time has expired the PCS

will automatically go through the internal pre-charge and connect process and then transition to the **Turn-On Delay** state. Once in this state, the PCS will wait the random delay specified in **REG 40303 – Enter Service Random Delay**. Once this time has expired, the PCS will turn on and ramp to the last commanded power setpoints at the rate specified in **REG 40305 – Enter Service Ramp Time**. This random delay and turn-on ramp rate are only used when automatically turning back on when service is re-enabled. If the PCS has not been commanded to operate prior to exiting the **Service Disabled** state, it will transition to the **Disabled** state and any subsequent attempts to turn the PCS on will follow the normal turn-on sequence described in the previous section.

The **Enter Service Delay Time** and **Enter Service Random Delay** can be bypassed by setting the respective register value to zero.

6.2.3 Active Power Control

Active power is directly controlled by writing the desired power, as a percentage of the maximum output power (W_{\max} , **REG 40266**), to **REG 40339 – Set Active Power Percent Setpoint**. **REG 40339** defaults to zero each time the PCS is powered on. This register uses signed values ranging from -100% to +100%, where a positive value indicates active power delivered to the grid and a negative value indicates active power absorbed from the grid. Once written to, this register retains the last command until bias power is removed.

Note that **REG 40333 – Set Active Power Enable** can be used to disable active power commands. When this register is set to “0”, the user’s active power command is ignored, and the PCS will ramp to a command of zero. When this register is set to a “1”, the PCS will ramp to the user’s last active power command.

When changing the active power command or when enabling/disabling the active power command while operating, the active power will be ramped at a rate defined by **REG 40360 – Active Power Ramp Rate**.

Although the user has direct control of the active power output, additional PCS features may limit or clamp the amount of active power available. These features are described in the following sections.

6.2.3.1 Limit Maximum Active Power

This feature can be used to limit the maximum active power delivered to the grid and is enabled using **REG 40325 – Limit Max Active Power Percent Enable**. When enabled, the maximum allowable output power, as a percentage W_{\max} in **REG 40266**, is commanded by writing to **REG 40326 – Limit Max Active Power Percent Setpoint**. Changes to this limit value are ramped at a fixed rate of 20% per second. Similarly, when this feature is disabled (or enabled), the limit value is ramped to (from) 100% allowable power at this same fixed ramp rate.

If the user commands active power to the grid above the limit value, the user command will be clamped to the limit value and the **Limit Active Power** warning bit will be set in **REG 41756 – PCS Warning Status**. Note that this feature only affects power *delivered to the grid*, i.e. the limit command ranges from 100% down to zero. It does not limit the ability to *pull power from the grid* (i.e. negative power commands) such as when charging batteries.

6.2.3.2 Volt/Watt Control

The PCS can be configured to limit the allowable active power delivered to the grid during over-voltage conditions, using the average of the measured three phase voltages. This behavior is implemented using a configurable array of Volt-Watt points that specify the desired piecewise linear characteristic. This curve must contain a minimum of two points, or up to a maximum of ten points. The Volt-Watt curve is created using the registers found in SunSpec Model 706, which is summarized in section 11.3.9. See section 11.2, “SunSpec Curve-Based Register Models” for general information on creating and modifying curves.

Figure 23 illustrates a basic Volt-Watt curve. At the endpoints, to the left of the first voltage point and to the right of the last voltage point, the power level remains constant (i.e. flat lines). The voltage points are defined as a percentage of the nominal grid voltage configured in **REG 40278**. The corresponding power limits are defined as a percentage of the PCS’s maximum active output power setpoint (W_{max}) configured in **REG 40266**. When the Volt-Watt curve is enabled (**REG 40455**), the user’s active power command will be not be allowed to exceed the value specified by this curve. When the user’s active power command is above this curve and is being clamped, the **Volt-Watt Active** warning bit will be asserted in **REG 41756 – PCS Warnings**.

The power limit is not required to stop at 0% as shown in the figure below and may continue below the X-axis. For example, a point P2 that is configured with a negative value would extend the curve below the X-axis, indicating that for high over-voltage conditions the PCS will be forced to absorb power from the grid.

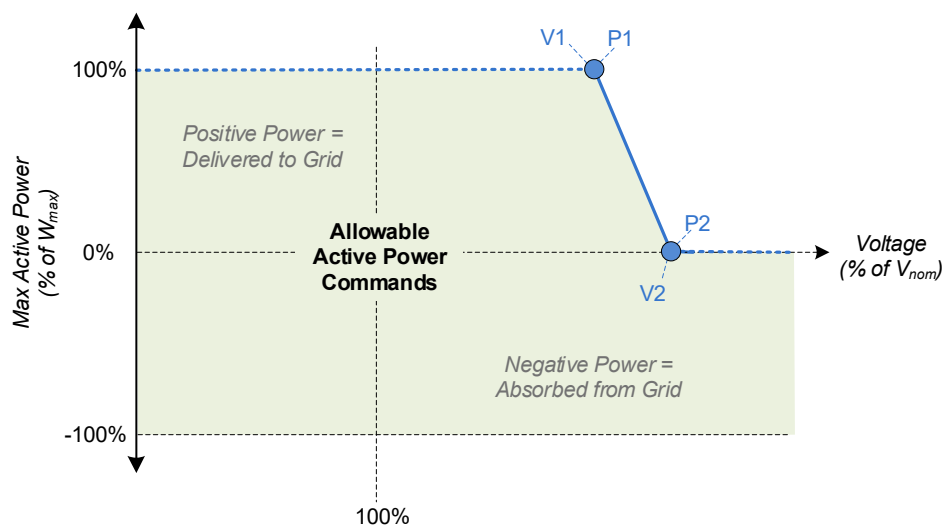

Figure 23 - Volt/Watt Configuration

The response time of the Volt-Watt function, i.e. how quickly the limit value changes due to changes in grid voltage or when changing the active curve settings while operating, is configurable using the associated **Response Time** register in the curve settings.



CAUTION

For the Volt-Watt curve, the voltage of each consecutive point in the curve must be higher than the previous point. Failure to meet this requirement will result in the curve being disabled, an **Invalid User Configuration** fault will be asserted in **REG 41758 – PCS Fault Status**, and the **Volt-Watt Curve Error** will be reported in **REG 41762 – User Configuration Error Status**.

6.2.3.3 Frequency/Watt Control

To support grid frequency stabilization during over-frequency and under-frequency conditions, the PCS may be optionally configured to automatically adjust the active power output based on the grid frequency measured at the PCS terminals. This feature is sometimes referred to as *Frequency Droop* control. This behavior is implemented using registers defined in the SunSpec Model 711, which is summarized in section 11.3.14. See section 11.2, “*SunSpec Curve-Based Register Models*” for general information on creating and modifying curves.

When the Frequency-Watt controller is enabled (**REG 41596**), the PCS will compare the measured grid frequency against the nominal frequency (F_{nom}) specified in **REG 41818 – Nominal AC Frequency Setting**. If the difference between the two is within the range specified by the over and under frequency deadband values (db_{UF} and db_{OF}) configured in the Frequency-Watt controller, then no action is taken, and the user’s active power command is used as-is without any adjustment. If the measured frequency deviates from F_{nom} by more than the configured deadband range, the active power setpoint is temporarily frozen at the value just prior to the frequency disturbance (P_{pre}) and the **Freq-Watt Active** warning bit will be set in **REG 41756 – PCS Warning Status**. When the active power setpoint is frozen, any attempts to change the setpoint will be ignored. The setpoint will remain frozen until the grid frequency returns to within the prescribed limits, at which point the PCS will ramp to the user’s most recent active power command. Although the user cannot control active power while the Frequency-Watt function is active, this does not affect the ability to turn the PCS off using **REG 41743 – Set Operation**.

For high frequency conditions, once the measured frequency is greater than the over-frequency deadband threshold above F_{nom} , the frozen pre-disturbance power setpoint is linearly *reduced* as the frequency increases beyond this point. The amount that the active power is reduced is based on the over-frequency change ratio (k_{OF}) configured in the Frequency-Watt controller. If the frequency continues to increase, the active power will continue to decrease until it reaches

the configured minimum power level P_{min} . This value is programmable by the user and would typically be set to 0% to stop reducing the active power when it reaches 0W, or to some negative value (as low as -100%), to allow the PCS to continue decreasing power such that it is forced to absorb power from the grid.

For low frequency conditions, the controller behaves similarly except that once the frequency is less than the under-frequency deadband threshold below F_{nom} , the pre-disturbance power setpoint is linearly *increased* as the frequency continues to drop, and the change in active power is based on the under-frequency change ratio (k_{UF}). As the frequency continues to decrease, the active power will continue to increase until it reaches the PCS's maximum active output power setpoint (W_{max}) configured in **REG 40266**.

In both cases, when the frequency begins to shift back towards F_{nom} , the adjusted active power command will re-trace the same curve until the frequency returns to within the prescribed deadband limits.

Figure 24 illustrates the basic Frequency-Watt behavior described above. Note that this diagram shows examples based on five different pre-disturbance active power setpoints, ranging from 100%, 50%, 0%, -50%, and -100%. It should be noted that P_{min} is meant to be set *below* the lowest active power level that the user anticipates commanding. If for some reason the pre-disturbance active power command is below the specified P_{min} value at the time that an over-frequency event occurs, the active power command will be frozen and remain at the pre-disturbance level. *It will not be forced to ramp up to the P_{min} value as this would be contradictory to the intended behavior of the Frequency-Watt function for over-frequency conditions.* This scenario is illustrated for the $P_{pre} = -100\%$ case shown in the figure below.

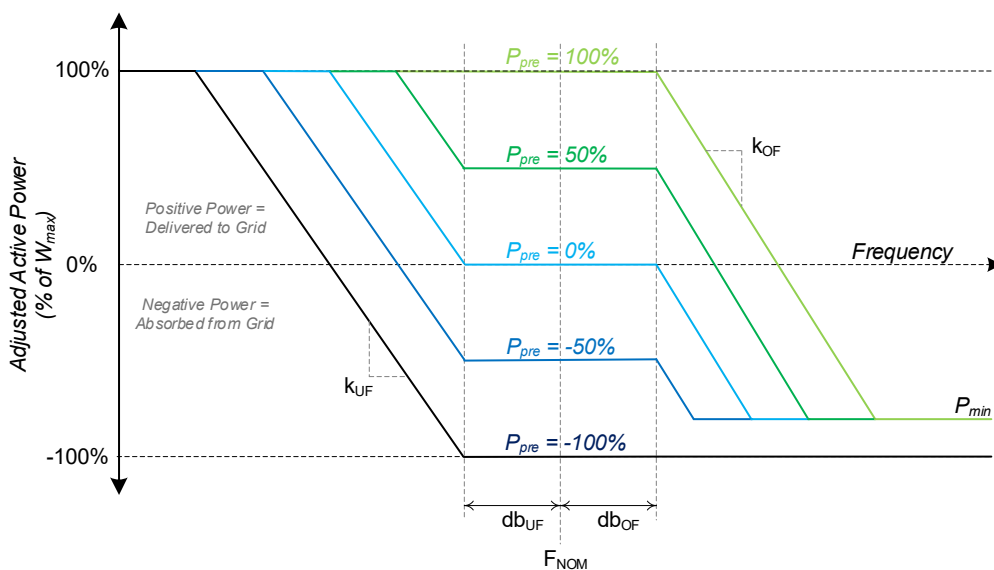

Figure 24 - Frequency/Watt Configuration

The table below shows the equations used to calculate the adjusted active power command for both under-frequency and over-frequency cases. For simplicity, the equations do not include the W_{max} (under-frequency) and P_{min} (over-frequency) clamping limits of the adjusted active power.

Table 9 - Frequency-Watt Control Equations

Under-Frequency Conditions	Over-Frequency Conditions
$P = P_{pre} + \frac{(F_{nom} - db_{UF}) - F_{meas}}{F_{nom} \cdot k_{UF}}$	$P = P_{pre} - \frac{F_{meas} - (F_{nom} + db_{OF})}{F_{nom} \cdot k_{OF}}$
Where: P = adjusted active power output P_{pre} = pre-disturbance active power command F_{nom} = nominal grid frequency from REG 41818 F_{meas} = measured grid frequency db_{UF}/db_{OF} = under/over frequency deadband specified in Freq-Watt model k_{UF}/k_{OF} = under/over change ratio specified in Freq-Watt model	

The response time of the Frequency-Watt function, i.e. how quickly the adjusted power command changes due to changes in grid frequency or when changing the controller settings while operating, is configurable using the associated **Response Time** register in the Freq-Watt Model.

6.2.3.4 Prioritization of Active Power Limiting Functions

As described above, several functions exist which, if enabled, can alter the user's desired active power setting. The order in which these functions are evaluated determines the priority of each. When updating the active power output, the PCS determines the new output command using the following sequence:

- 1) If **Active Power Setpoint** is enabled (**REG 40333**), read the commanded value from **REG 40339**, otherwise the commanded value is set to 0%.
- 2) If **Limit Maximum Active Power** is enabled (**REG 40325**), clamp the value from step #1 to the max limit specified in **REG 40326** if necessary
- 3) If the **Frequency-Watt** function is enabled (**REG 41596**), determine if the grid frequency is outside the configured limits; if so, use the pre-disturbance active output power and adjust this value based on the Freq-Watt curve, otherwise use the value from step #2 above
- 4) If the **Volt-Watt** function is enabled (**REG 40455**), determine the maximum allowable active power output based on the grid voltage and clamp the value from step #3 to this value if necessary

6.2.4 Reactive Power Control

The PCS provides the following methods for controlling reactive power to or from the grid:

- **Constant Reactive Power** – reactive power is directly controlled from a user-specified setpoint
- **Power Factor Control** – reactive power is controlled based on the user-specified power factor and the present active power output
- **Volt/VAR Control** – reactive power is controlled as a function of the measured grid voltage
- **Watt/VAR Control** – reactive power is controlled as a function of the active power output

The above reactive power control functions are mutually exclusive, meaning only one can be enabled at any given time. Enabling any function while another is active will automatically disable the presently used function before switching to the newly selected function. If all the above functions are disabled, the PCS will operate at unity power factor (i.e. zero reactive power).

When Power Factor control is selected, if the resulting total apparent power exceeds the PCS maximum apparent power setting (VA_{max} , **REG 40271**), both the active and reactive power setpoints will be reduced to achieve the desired power factor. For the other three modes, if the resulting total apparent power exceeds VA_{max} , the active versus reactive power priority will be based on the mode-specific priority setting as described in the following sections. If active power priority is selected, the PCS will reduce the commanded reactive power in order to maintain the desired active power. If reactive power priority is selected, the PCS will reduce the commanded active power in order to deliver the desired reactive power, up to the limit specified in **REG 41817 – Reactive Power Priority VAR Limit**. This register can be set to 100% to prioritize *all* reactive power over active power. Otherwise, when this register is set to a lower value (for example, 44% of VA_{max} as required by IEEE-1547), the PCS prioritizes reactive power commands up to the specified limit. Any reactive commands above this limit may be reduced to this value, if necessary, in order to use the remaining VA headroom for active power. In all cases, when power is being limited based on the VA_{max} setting, the **AC Power Limit** warning bit will be set in **REG 41756 – PCS Warning Status**.

6.2.4.1 Constant Reactive Power Control

When this mode is enabled (**REG 40346 – Set Reactive Power Enable**), the user can specify the reactive power by writing the desired value, as a percentage, to **REG 40353 – Set Reactive Power Percent Setpoint**. By default, this command is a percentage of the maximum reactive power (VAR_{max} , **REG 40272**). However, the scaling can be changed to be a percentage of the maximum active power (W_{max} , **REG 40266**) or the maximum apparent power (VA_{max} , **REG 40271**) by changing **REG 40347 – Set Reactive Power Mode**. The reactive power setpoint register uses signed values ranging from -100% to +100%, where a positive value indicates reactive power delivered to the grid (over-excited) and a negative value indicates reactive

power absorbed from the grid (under-excited). This is a non-volatile register, and the last value written by the user will be retained when power cycling the PCS, and each time the PCS is turned on.

When changing the reactive power setpoint, or when enabling/disabling constant reactive power control while the PCS is operating, the reactive power will be ramped at a rate defined by **REG 40362 – Reactive Power Ramp Rate**.

When operating in this mode and the combined active and reactive power commands exceed the maximum apparent power setting (VA_{max} , **REG 40271**), the active versus reactive power priority is determined by **REG 40348 – Set Reactive Power Priority**.

6.2.4.2 Power Factor Control

Power factor control mode can be enabled using **REG 40313/40319 – Power Factor Enable - Injecting/Absorbing Watts**. Although the standard SunSpec DER AC Controls Model 704 provides these separate enables based on the active power direction, the PCS does not support independent power factor enables for injecting versus delivering active power. Writing a '1' to either register will result in both being set to '1' and power factor commands for both active power directions being enabled. Similarly, writing a '0' to either register will result in both being set to '0' and power factor control being disabled.

When power factor control is enabled, the user specifies the power factor to use when the PCS is injecting active power to the grid by first writing the desired power factor value to **REG 40370 – Power Factor Setpoint When Injecting Watts**. This is an unsigned register that accepts power factor values between 0.000 and 1.000. Next, the desired reactive power direction is specified by writing to **REG 40371 – Power Factor Excitation When Injecting Watts** (0 = over-excited, 1 = under-excited). The power factor value written to **REG 40370** is temporarily latched but not used until the direction is written to **REG 40371**. Writes to the direction register are ignored if the power factor value has not been previously written and latched.

Similarly, to specify the power factor to use when the PCS is absorbing active power from the grid, the user must write to **REG 40374 – Power Factor Setpoint When Absorbing Watts** and **REG 40375 – Power Factor Excitation When Absorbing Watts**, using the same rules described in the previous paragraph.

The power factor setpoint and excitation registers are non-volatile, and the last value written by will be retained when power cycling the PCS, and each time the PCS is turned on in power factor control mode. While operating, if the power factor setpoint for the current active power direction is changed, if the active power direction changes causing the power factor setpoint to change between the two directions, or when enabling/disabling power factor control mode, the resulting change in reactive power will be ramped at a rate defined by **REG 40362 – Reactive Power Ramp Rate**.

When decreasing the power factor setpoint (i.e. increasing reactive power), if the resulting reactive power is greater than the maximum reactive power value (VAR_{max} , **REG 40272**), it will be limited to VAR_{max} , the active power output will be reduced to maintain the specified power factor, and the **AC Power Limit** warning bit is set in **REG 41756 – PCS Warning Status**. Similarly, if the combination of the active and reactive power setpoints exceed the maximum apparent power value (VA_{max} , **REG 40271**) both will be proportionally reduced such that the resulting combined apparent power is VA_{max} , the desired power factor is maintained, and the **AC Power Limit** warning will be set.

6.2.4.3 Volt/VAR Control

To support grid voltage stabilization during over-voltage and under-voltage conditions, the PCS may be optionally configured to automatically generate reactive power commands based on the average of the three grid voltages measured at the PCS terminals. This behavior is implemented using a configurable array of up to ten Volt-VAR points that specify the desired piecewise linear characteristic. The Volt-Watt curve is created using the registers found in SunSpec Model 706, which is summarized in section 11.3.9. See section 11.2, “*SunSpec Curve-Based Register Models*” for general information on creating and modifying curves.

Figure 25 illustrates a basic Volt-VAR curve that consists of four points. At the endpoints, to the left of the lowest voltage point and to the right of the highest voltage point, the VAR level remains constant (i.e. flat lines). The voltage points are defined as a percentage of the nominal grid voltage configured in **REG 40278**. By default, the reactive power points are defined as a percentage of the maximum reactive power (VAR_{max} , **REG 40272**). However, the scaling can be changed to be a percentage of the maximum active power (W_{max} , **REG 40266**) or the maximum apparent power (VA_{max} , **REG 40271**) using the *VAR Dependent Reference* register in the Volt-VAR curve settings.

**CAUTION**

The voltage of each consecutive point in the curve must be higher than the previous point. Failure to meet this requirement will result in the curve being disabled and an **Invalid User Configuration** fault will be asserted. The offending curve is reported in **REG 41762 – User Configuration Error Status**.

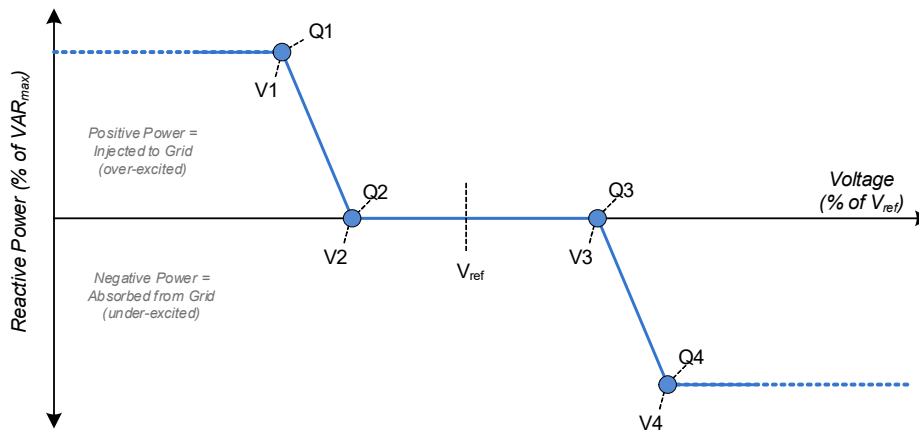

Figure 25 - Volt/VAR Configuration

When the Volt-VAR function is enabled (**REG 40380**), the reactive power setpoint will follow the specified Volt-VAR curve by comparing the measured grid voltage against a reference voltage (V_{ref}) and determining how much reactive power to inject or absorb from the grid. By default, V_{ref} is set to the nominal grid voltage (V_{nom}) specified in **REG 40278**. When the **Autonomous V_{ref} Enable** register is set to “1” in the curve settings, the V_{ref} value is dynamically adjusted by as much as $\pm 5\%$ of V_{nom} to slowly track changes in the grid voltage. When autonomous adjustments are enabled, V_{ref} will follow the filtered grid voltage measurement using a very long time constant (i.e. minutes) specified in the **Autonomous V_{ref} Time Constant** register in the curve settings. If the grid voltage deviates by more than $\pm 5\%$ of V_{nom} , the autonomous V_{ref} value will be clamped at $V_{nom} \pm 5\%$. Using autonomous V_{ref} adjustments allows the Volt-VAR function to respond to transient grid voltage changes while not reacting to very slow drifts in grid voltage.

When autonomous adjustments are disabled, a fixed V_{ref} value can be specified in the static **V_{ref} Adjustment** register in the curve settings. However, in this case the voltage points in the Volt-VAR curve must be configured as a percent of the nominal grid voltage (V_{nom}) and manually adjusted up or down in the register settings based on changes in the desired fixed V_{ref} .

When the Volt-VAR function is resulting in a non-zero reactive power command, the **Volt-VAR Active** warning bit will be asserted in **REG 41756 – PCS Warnings**. How quickly the reactive

power changes due to changes in grid voltage or when changing the active curve settings while operating, is configurable using the associated **Response Time** register in the curve settings.

When operating in Volt-VAR mode and the combined active and reactive power commands exceed the maximum apparent power setting (VA_{max} , **REG 40271**), the active versus reactive power priority is configurable using the associated **Power Priority** register in the curve settings.

6.2.4.4 Watt/VAR Control

The PCS can be configured to inject or absorb reactive power as a function of its active power output. This behavior is implemented using a configurable array of up to ten Watt-VAR points that specify the desired piecewise linear characteristic. The Watt-VAR curve is created using the registers found in SunSpec Model 712, which is summarized in section 11.3.15. See section 11.2, “*SunSpec Curve-Based Register Models*” for general information on creating and modifying curves.

Figure 26 illustrates a basic Watt-VAR curve. At the endpoints, to the left of the first active power point and to the right of the last active power point, the reactive power level remains constant (i.e. flat lines). The active power points (P) are defined as a percentage of the maximum active power (W_{max} , **REG 40266**). By default, the reactive power points (Q) are defined as a percentage of the maximum reactive power (VAR_{max} , **REG 40272**). However, the scaling can be changed to be a percentage of the maximum active power (W_{max} , **REG 40266**) or the maximum apparent power (VA_{max} , **REG 40271**) using the *VAR Dependent Reference* register in the Watt-VAR curve settings. When the Watt-VAR curve is enabled (**REG 41630**), the PCS’s active power output is used to determine the reactive power output specified by this curve. When the result is a non-zero reactive power command, the **Watt-VAR Active** warning bit will be asserted in **REG 41756 – PCS Warnings**.



CAUTION

Each consecutive active power (P) point in the curve must be higher than the previous point. Failure to meet this requirement will result in the curve being disabled and an **Invalid User Configuration** fault will be asserted. The offending curve is reported in **REG 41762 – User Configuration Error Status**.

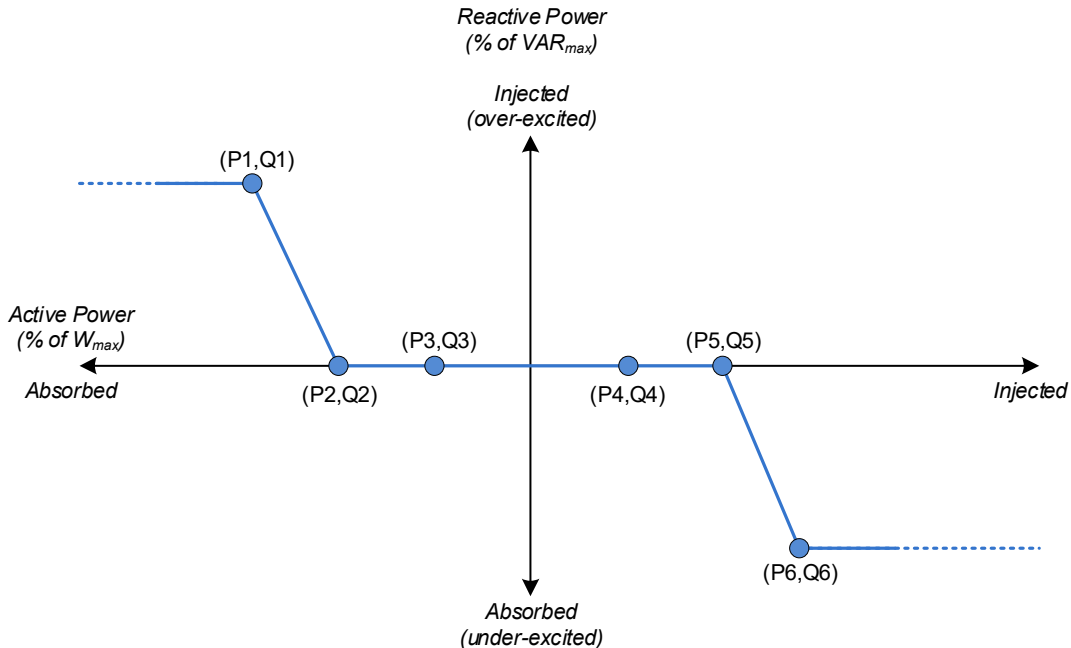

Figure 26 - Watt/VAR Configuration

Changes in the reactive power output as a result of changes in the active power setpoint, or when enabling/disabling the Watt-VAR controller, will be ramped at a rate defined by **REG 40362 – Reactive Power Ramp Rate**.

When operating in Watt-VAR mode and the combined active and reactive power commands exceed the maximum apparent power setting (VA_{max} , **REG 40271**), the active versus reactive power priority is configurable using the associated **Power Priority** register in the curve settings.

6.2.5 Output Power and Current Limiting

As discussed in the previous section, when the combined active and reactive power commands exceed the PCS's maximum apparent power setting (VA_{max} , **REG 40271**), which command is given priority and which is reduced first is based on the selected reactive power control mode and its particular power priority setting. Similarly, if the operating grid voltage is low enough such that the required AC current exceeds the value in **REG 40281 – Setting for Maximum AC Current**, the power commands will be reduced using the same priority criteria as the VA_{max} power limiting in order to keep the AC current from exceeding the specified maximum value. When this occurs, the **AC Current Limit** warning bit will be set in **REG 41756 – PCS Warning Status**.

At lower DC voltages, the power capability of the PCS is limited by the **Maximum DC Charge/Discharge Current** settings, **REG 41748-41749**. Under these conditions the PCS will limit the active AC power to keep from exceeding these DC current settings. When this occurs, the **DC Power Limit** warning bit will be set in **REG 41756 – PCS Warning Status**.

6.2.6 Unbalanced Voltage Compensation

When operating in Grid Tie mode, the PCS provides a mechanism to assist in balancing the three-phase voltages at its terminals. This feature is based on symmetrical component theory, which states that any asymmetrical set of phasors (in this case, the sensed AC voltage) can be expressed as a linear combination of symmetrical sets of phasors. In a three-phase system, the symmetrical components are referred to as the positive sequence, negative sequence, and zero sequence components.

For balanced grid conditions, the negative and zero sequence components are not present (zero magnitude) and the positive sequence vectors alone can represent the grid voltage. When the grid voltage becomes unbalanced, negative sequence vectors are introduced. The amplitude and phase of these vectors depends on the unbalance conditions.

6.2.6.1 Negative Sequence Current Control

If enabled in **REG 41831 – Voltage Unbalance Control Enable**, the PCS will inject negative sequence currents into the grid to mitigate the voltage unbalance conditions. The negative sequence current magnitudes are proportional to the voltage error (i.e., negative sequence voltage amplitude), according to the gain specified in **REG 41833 – Voltage Unbalance Control Gain**.

Generally, when multiple PCS are operated in parallel, co-located at the same PCC with the same connection impedance, the amount of negative sequence current injected from each unit will be similar. However, if the units are not co-located or do not have the same grid interface impedance, they may not evenly share the negative sequence control currents. To ensure balanced compensation between units when operating under these circumstances, a droop control function is used to reduce the controller gain as the negative sequence load current increases. This droop gain is configured in **REG 41835 – Voltage Unbalance Droop Gain**.

When enabling unbalance voltage compensation Oztek recommends using the default control and droop gains. If necessary, contact Oztek technical support to discuss systems that require changes from these default settings.

6.2.6.2 Negative Sequence Current Limit and Priority

When injecting both positive sequence current (i.e., from user power commands) and negative sequence current (from voltage unbalance control), the resulting three phase output currents will sum to zero, but the amplitudes and phase of the individual phase currents will differ from one another based on the amplitude of the positive and negative sequence currents and the phase relationship between the two. The amplitude of the resulting phase currents will be the sum of the positive and negative sequence current vectors.

The negative sequence current command from the voltage unbalance controller is considered a secondary support feature of the PCS, and as such, the positive sequence current command from the user's power setpoints and other grid support functions is given priority over the

negative sequence current. The resulting negative sequence current command will be limited to the PCS rated current less any positive sequence current commands. When this situation occurs, the **Negative Sequence Current Limit** warning bit will be set in **REG 41756 – PCS Warning Status**.

6.2.7 Anti-Island Detection

While online and operating in Grid Tie mode, each PCS provides independent anti-islanding protection by monitoring the grid voltage for instability. Islanding can occur when a distributed generation source continues to energize a portion of the utility grid (the island) after the utility has stopped providing power.

The PCS provides an active island detection mechanism that uses very small perturbations to the output power and looks for a corresponding change in the sensed grid voltage. The detection time for this mechanism is typically in the range of 600-800ms.

Island detection can be enabled or disabled using **REG 40363 – Anti-Islanding Enable**. The PCS behavior when an island is detected can be configured using **REG 41828 – Anti-Island Detector Mode Select**.

6.2.8 Grid Fault Ride Through

The PCS provides highly configurable grid fault ride through functionality to individually address low and high frequency ride through (LFRT, HFRT) conditions as well as low and high voltage ride through (LVRT, HVRT) scenarios. For each condition, two curves can be defined by the user; one representing the “must trip” criteria and one representing the “momentary cessation” criteria.

Figure 27 below shows a generic example of the trip and cessation curves. If the grid voltage/frequency exceeds the inner-most trip thresholds but has not yet exceeded the specified cessation or trip durations, i.e. crosses from the green region into the orange region, the PCS will continue to operate normally but will transition to the **Ride Through Active** state to indicate that a ride through event has been triggered and is currently being timed.

If the voltage/frequency exceeds the “momentary cessation” curve’s threshold and duration (shown with blue lines), i.e. crosses the blue line into the yellow region, the PCS will remain connected to the grid but will stop processing power and will transition to the **Ride Through Passive** state. If the voltage/frequency returns to near nominal levels, i.e. crosses back over the blue line from the yellow region, the PCS will go back to processing power per the user setpoints, returning to the **Ride Through Active** state.

If the voltage/frequency exceeds the “must trip” curve’s threshold and duration (shown with red lines), i.e. crosses the red line into the pink region, the PCS will trip off and go to the **Offline** state, or immediately go to the **Fault** state if **REG 41825 – Auto-Resume Timeout** is set to zero.

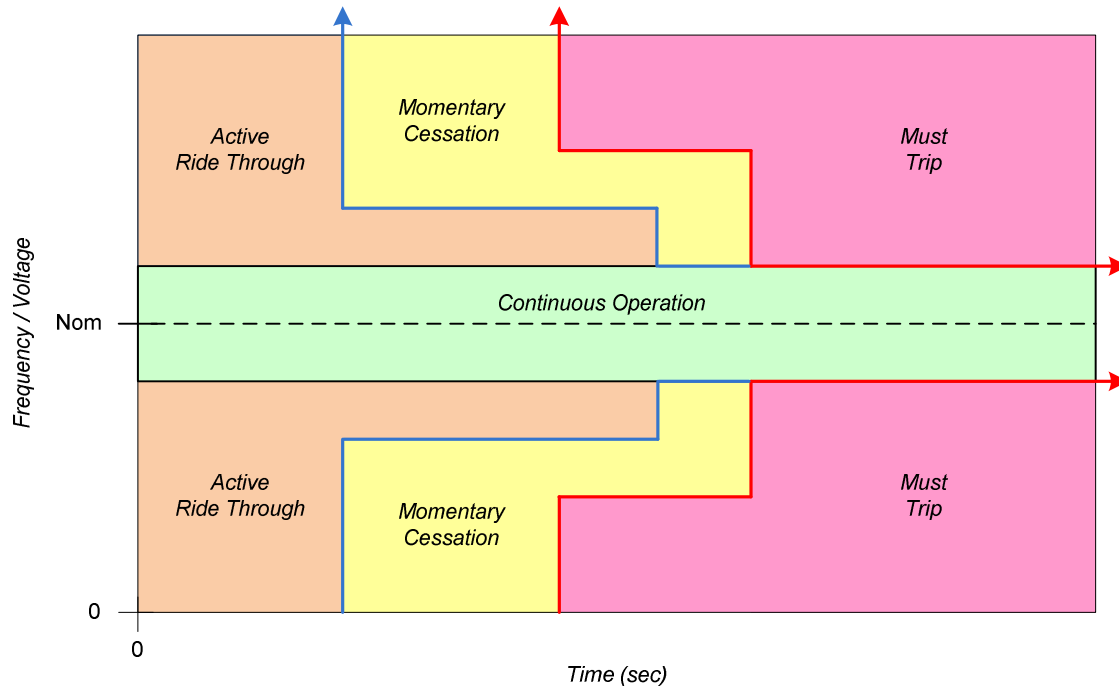

Figure 27 - Ride Through Cessation and Trip Curves

NOTE: The “momentary cessation” and “must trip” curves are independently programmable. For this reason, the “must trip” curve will always take priority over the “momentary cessation” curve if the curves (blue and red lines) intersect.

6.2.8.1 Low/High Voltage Ride Through

The Low/High Voltage Ride Through (L/HVRT) “must trip” and “momentary cessation” curves are implemented using configurable arrays of X-Y points to allow the user to define multiple voltage/duration boundary conditions. Two different sets of curves are provided, one for low voltage conditions and one for high voltage conditions. These curves are defined using the registers found in the SunSpec “*DER Low/High Voltage Trip*” Models 707 and 708, respectively (see sections 11.3.10 and 11.3.11). See section 11.2, “*SunSpec Curve-Based Register Models*” for general information on creating and modifying curves.

These models provide up to 12 points to create each curve. It is not required that all 12 points be defined and used - a separate register is used to specify the actual number of points defined in each array

Figure 28 illustrates the factory default L/HVRT curves, which are compliant with the IEEE 1547-2018 Category III default settings shown in Table 10. LD1..LD5 represent the points in the low voltage “must trip” array defined in Model 707, whereas HD1..HD5 represent the points in the high voltage “must trip” array defined in Model 708. Note that the first line segment is extended horizontally to the left or vertically based on the slope of the first pair of points, and that the curve after the last point is always extended horizontally to the right.

Table 10 - IEEE 1547-2018 Default L/HVRT Trip Settings

Region	Voltage (%)	Clearing Time (s)	Operating Mode
OV2	> 120	0.16	n/a
OV1	> 110	13	Momentary Cessation
Normal	$88 \leq V \leq 110$	n/a	Continuous Operation
UV1	< 88	21	Mandatory Operation
UV2	< 50	2	Momentary Cessation

**CAUTION**

The points in the voltage trip curve arrays must adhere to the following rules. Failure to meet these restrictions will result in an **Invalid User Configuration** fault. The offending table is reported in **REG 41762 – User Configuration Error Status**.

- Line segments are defined by two adjacent points and must be either horizontal or vertical (i.e. the duration or voltage value must be the same for any two adjacent points) – ramped segments are not supported
- A curve must contain at least one line segment (i.e. two points minimum)
- The duration value for each point must be equal to or longer than the previous point
- The voltage value for each point must be equal to the previous point or closer to the nominal voltage than the previous point

The “momentary cessation” curves are defined using the exact same point definitions and programming requirements as the “must trip” curves described above, with each curve supporting up to 12 points. Note that IEEE 1547-2018 requires “momentary cessation” for High Voltage Region 1, and for Low Voltage Region 2. For these cases, a single line segment (i.e. 2 points) is sufficient to meet this requirement as shown by the blue points in Figure 28 below.

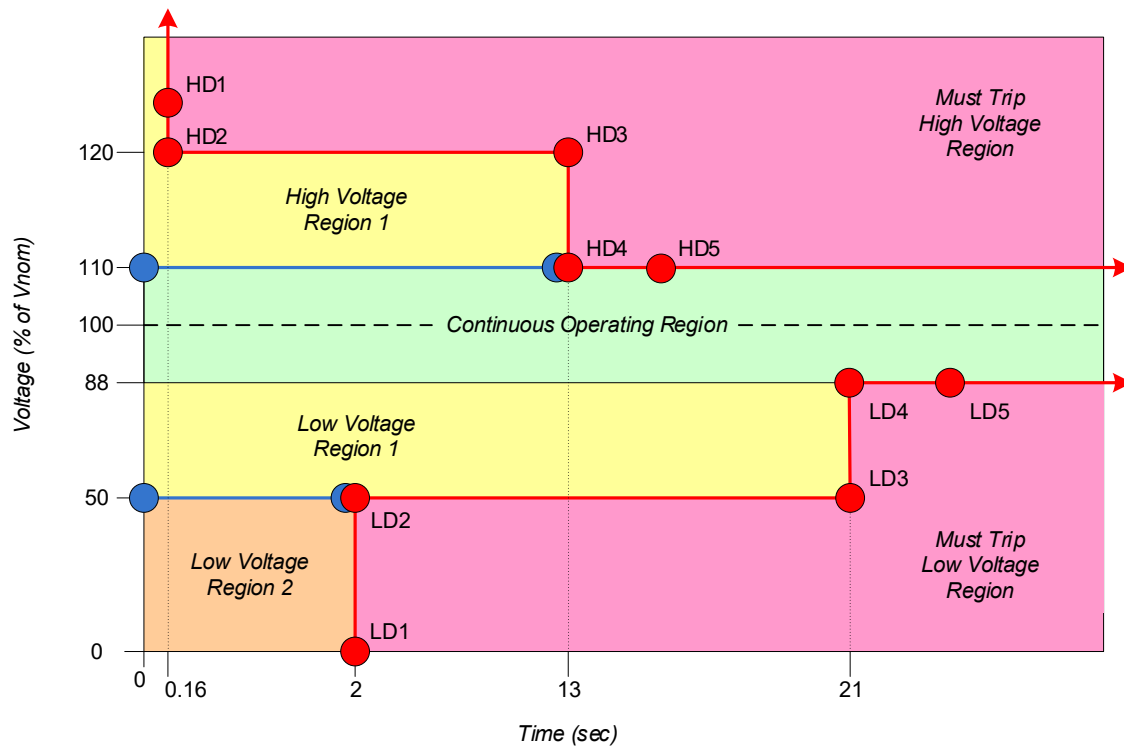

Figure 28 - Voltage Ride Through IEEE 1547-2018 Configuration

For the High Voltage Ride Through “momentary cessation” curve, any voltage threshold set above the Maximum Active Ride Through V_{MAX} (see section 2.2 “*Electrical Specifications*”) will be forced to this value and the **HVRT Active Override** warning bit will be set in **REG 41756 – PCS Warning Status**. Similarly, if **REG 40753 – HVRT Module Enable = 0 (Disabled)**, then a default curve with a threshold set to the Maximum Active Ride Through Voltage and a duration of zero will be used and the **HVRT Active Override** warning bit will be set. If in this case it is undesirable for the PCS to operate with momentary cessation under high line voltage conditions, then the user should configure the High Voltage “must trip” function with an immediate trip threshold at the Maximum Active Ride Through Voltage threshold.

For the “must trip” curves, if the LVRT or HVRT curves are disabled (**REG 40520/40753**), or if there is an error in the active curve points, the corresponding **Default Grid High/Low Voltage Threshold** registers (**REG 41819/41820**) will be used to define the immediate disconnect threshold.

REG 41829 – AC Connection Type is used to determine which AC voltages are monitored. When this register is set for a four-wire interface, all three line-to-line voltages are monitored as well as the three individual line-to-neutral voltages. When this register is set for a three-wire interface, only the three line-to-line voltages are monitored.

6.2.8.2 Low/High Frequency Ride Through

The Low/High Frequency Ride Through (L/HFRT) “must trip” and “momentary cessation” curves are implemented using configurable arrays of X-Y points to allow the user to define multiple frequency/duration boundary conditions. Two different sets of curves are provided, one for low frequency conditions and one for high frequency conditions. These curves are defined using the registers found in the SunSpec “*DER Low/High Frequency Trip*” Models 709 and 710, respectively (see sections 11.3.12 and 11.3.13). See section 11.2, “*SunSpec Curve-Based Register Models*” for general information on creating and modifying curves.

These models provide up to 12 points to create each curve. It is not required that all 12 points be defined and used - a separate register is used to specify the actual number of points defined in each array.

Figure 29 illustrates the factory default L/HFRT curves, which are compliant with the IEEE 1547-2018 default settings shown in Table 11. LD1..LD5 represent the points in the low frequency “must trip” array defined in Model 709, whereas HD1..HD5 represent the points in the high frequency “must trip” array defined in Model 710. Note that the first line segment is extended horizontally to the left or vertically based on the slope of the first pair of points, and that the curve after the last point is always extended horizontally to the right.

Table 11 - IEEE 1547-2018 Default L/HFRT Trip Settings

Region	Frequency (Hz)	Clearing Time (s)	Operating Mode
OF2	> 62.0	0.16	n/a
OF1	> 61.2	300	Mandatory Operation
Normal	$58.5 \leq f \leq 61.2$	n/a	Continuous Operation
OF1	< 58.5	300	Mandatory Operation
OF2	< 56.5	0.16	n/a



CAUTION

The points in the frequency trip curve arrays must adhere to the following rules. Failure to meet these restrictions will result in an **Invalid User Configuration** fault. The offending table is reported in **REG 41762 – User Configuration Error Status**.

- Line segments are defined by two adjacent points and must be either horizontal or vertical (i.e. the duration or frequency value must be the same for any two adjacent points) – ramped segments are not supported
- A curve must contain at least one line segment (i.e. two points minimum)
- The duration value for each point must be equal to or longer than the previous point
- The frequency value for each point must be equal to the previous point or closer to the nominal frequency than the previous point

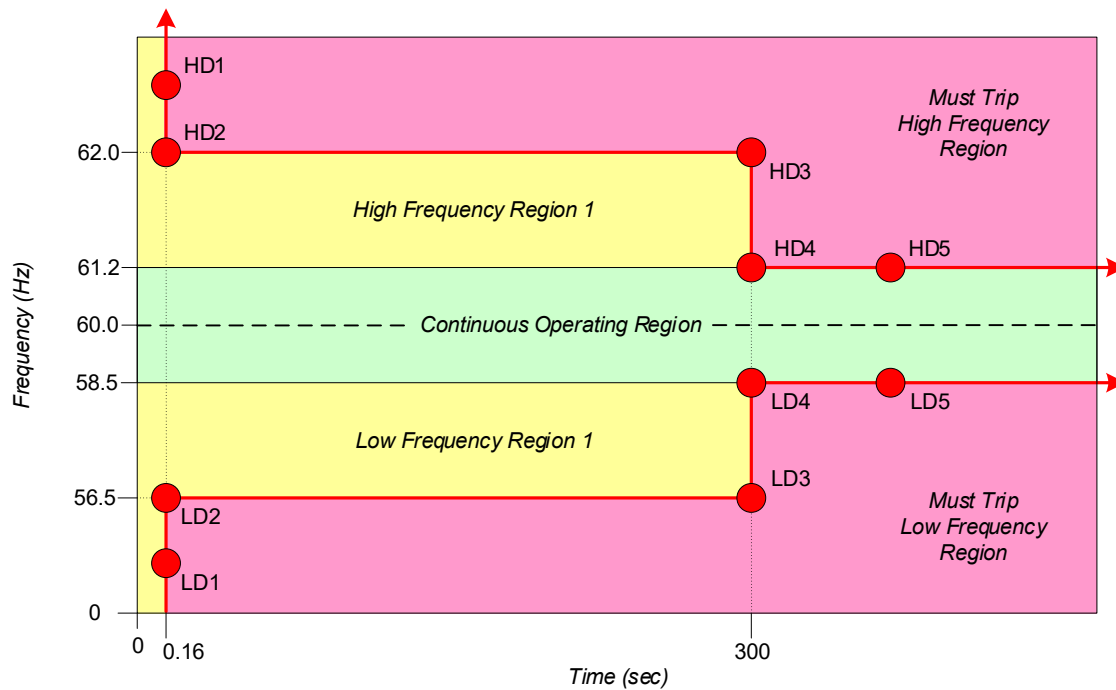

Figure 29 - Frequency Ride Through IEEE 1547-2018 Configuration

The Low/High Frequency Ride Through (L/HFRT) “momentary cessation” curves are defined using the exact same point definitions and programming requirements as the “must trip” curves described above, with each curve supporting up to 12 points. Note that “momentary cessation” is not required for IEEE 1547-2018, so the points for these curves default to values outside of the “must trip” regions such that no “momentary cessation” is enforced.

For the “must trip” curves, if the LFRT or HFRT curves are disabled (**REG 40986/41291**), or if there is an error in the active curve points, the corresponding **Default Grid High/Low Frequency Threshold** registers (**REG 41821/41822**) will be used to define the immediate disconnect threshold.

6.3 Grid Forming (Island) Operating Mode

When configured for Grid Forming (Island) mode (see **REG 41747** and **REG 41813**), the PCS operates as an AC voltage source that is capable of running in parallel with other voltage sources, such as diesel generators, wind turbines, or other grid forming PCS’s. For systems requiring both grid tie as well as Island mode operation, the PCS relies on an external static transfer switch (STS) to isolate the micro-grid from the utility in the case of grid faults and to reconnect seamlessly to the grid when the faults are cleared. Local loads are connected to the micro-grid side of the switch such that they can remain powered by the island during a grid fault.

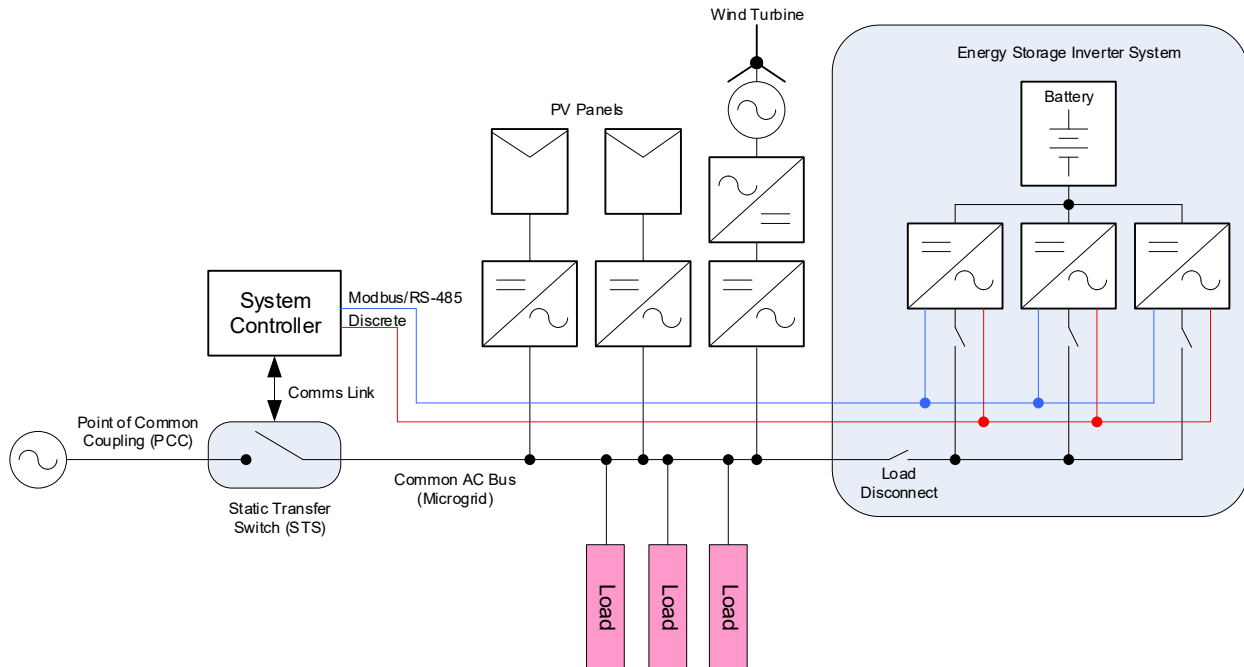

Figure 30 - Island Mode Capable System Block Diagram

When operating in Grid Forming mode, the PCS accepts voltage and frequency commands from the user. **REG 42213 – Grid Form Voltage Command** sets the nominal voltage of the Island and **REG 42214 – Grid Form Frequency Command** sets the nominal frequency. When the PCS is first powered on, or any time the PCS mode is changed from Grid Tie to Grid Forming, these registers are initialized with the values from **REG 40278 – Nominal AC Voltage Setting** and **REG 41818 – Nominal AC Frequency Setting**, respectively. The user may subsequently change the nominal island voltage or frequency using **REG 42213/42214**.

Droop controllers are used to regulate the exchange of active and reactive power with the Island or “micro-grid” in order to keep the frequency and amplitude under control. Droop methods are based on the self-regulation capability of the synchronous generator in grid-connection mode, in which the impedance between the generators and the grid is considered inductive, decreasing the delivered active power when the grid frequency increases and decreasing the injected reactive power when the grid voltage amplitude increases.

By default, the droop controllers operate with zero active and reactive power when the microgrid frequency and voltage are equal to their commanded setpoints. The PCS also provides two offset registers, **REG 42215 – Grid Form Active Power Offset** and **REG 42216 – Grid Form Reactive Power Offset** that allow the user to offset these zero bias points. These registers default to the values defined in **REG 42223 – Grid Form Active Power Offset Turn-On Default** and **REG 42226 – Grid Form Reactive Power Offset Turn-On Default** any time the PCS is being turned on in grid forming mode. These values are typically set to zero. However, the user can change the offsets as needed, for instance to offset the power drawn from one bank of batteries compared to the others, or to force power into one bank for charging purposes.

6.3.1 Initiating Grid Forming Operation

Similar to Grid Tie operation, when first powered up in Grid Forming mode, the PCS's internal DC and AC contactors are both open. Prior to operating the PCS, it must first be commanded to close these contactors by first writing a "1" to **REG 41743 – Set Operation**. The PCS response to this command depends on the state of the AC voltage sensed at the PCS terminals.

If a valid microgrid is already present (determined by **REG 42244 – 42247**), i.e. powered by some other resource, then the PCS will perform a similar internal pre-charge process as Grid Tie mode and will then close the DC and AC contactors and go to the **Standby** state. At this point the PCS can be turned on by writing a "3" to **REG 41743 – Set Operation**. The PCS will then begin operating in Grid Forming mode using the voltage and frequency sensed at the AC terminals, and then ramp to the user's commanded setpoints (**REG 42213/42214**) using the ramp rates configured in **REG 42219 & 42222**.

If no AC voltage is present (must be below 10 V_{RMS} line-to-line), the microgrid must be black started by the PCS. In this case, the PCS will first perform the internal DC pre-charge process and will then close DC and AC contactors and go to the **Standby** state. When the PCS is then turned on by writing a "3" to **REG 41743**, it will begin ramping the voltage to the user's commanded setpoint (**REG 42213**) at the rate specified in **REG 42230 – Grid Form Startup Voltage Slew Rate**.

If the PCS is commanded to "connect" but the sensed AC voltage is above the maximum black start voltage (10 V_{RMS}) and a valid microgrid is not present (**REG 42244 – 42247**), then the PCS will go to the **Charge Wait** state and wait for one of these two conditions to be true. Similarly, if the PCS has already connected and is in the **Standby** state (i.e. not yet turned on), and the microgrid is no longer valid or the sensed voltage rises above the maximum black start voltage, the PCS will open both contactors and go to the **Charge Wait** state.

Once the PCS is on and operating in Grid Forming mode, any changes to the user's commanded voltage or frequency setpoints (**REG 42213/42214**) will cause the PCS to ramp to the new setpoints at the ramp rates configured in **REG 42219 & 42222**.

When the PCS is turned on into an existing microgrid in either Grid Tie mode or in Grid Forming, it will sense the present phase rotation of the AC voltage and store this in a non-volatile register. Any time the PCS is black started in Grid Forming mode, it will turn on and operate with the phase rotation stored from the last time the PCS was operated. For systems that are intended to operate in both Grid Tie and Grid Forming modes and are sensitive to phase rotation, the operator should first start the PCS in Grid Tie mode (i.e. synchronized to an existing AC voltage) to set the intended phase rotation and ensure that this is used the first time the PCS is black started in Grid Forming mode.

6.3.2 Parallel Black Start

The local microgrid can be black started by multiple PCS units operating in parallel. To do so, they all need to be started at the exact same point in time. In order to meet this requirement, all PCS units must be tied to the same physical RS-485 serial bus, and the dedicated Modbus broadcast device address of zero must be used when turning the PCS on (writing a “3” to **REG 41743 – Set Operation**).

It is recommended that **REG 42230 – Grid Form Startup Voltage Slew Rate** be configured for the default slew rate or slower when black starting multiple PCS’s at the same time. Otherwise, slight voltage mismatches when ramping at extremely fast rates can cause noticeable currents to circulate between units. These currents will not cause harm to the PCS, but when combined with local loads at startup, this could cause nuisance over-current trips and failure to reliably black start the microgrid.

Parallel black start is not possible if all PCS units cannot be attached to the same physical RS-485 serial bus. In this case, black starting the microgrid is still possible, but requires a manual black start process by the operator. In this scenario, a single PCS must first be black started by itself. If the local loads are greater than the power ratings of a single unit, they must be disconnected from the PCS’s during the manual black start procedure. Once the first unit has finished black starting and the local voltage has been established, the remaining PCS units will synchronize to the first unit and may then be individually turned on. Once all units are operating, the local loads may then be attached.

6.3.3 Microgrid Monitoring

When operating in a true microgrid with other distributed sources, the local voltage and frequency will vary based on factors such as the load conditions and the differences in power ratings, voltage/frequency references, droop gains, and impedances (real or virtual) between sources, etc. For a properly architected system that takes all of these into account, it should be possible to confine the overall acceptable range of operating voltage and frequency of the microgrid. The PCS provides a means to monitor the microgrid voltage and frequency and detect cases where they move outside the expected operating range. If the microgrid moves outside of the range specified by **REG 42232/42233 – Grid Form Maximum/Minimum Operating Voltage** or **REG 42234/42235 – Grid Form Maximum/Minimum Operating Frequency**, the PCS will turn off and transition to the **Offline** state. It will remain in this state until the microgrid returns to acceptable levels (determined by **REG 42244 – 42247**) or the user manually disables the PCS and attempts to restart the microgrid. In systems where the PCS(s) is the only source of power for the local microgrid, the latter will be necessary in order to bring the microgrid back up.

6.3.4 Single Unit Standalone Operation

For systems which use a single PCS as the only source of the local AC voltage, it is recommended that droop control and virtual impedance are turned off. By doing so, the PCS

will act as an AC power supply, regulating the output voltage and frequency to the commanded setpoints without any additional droop due to load conditions. This can be done by setting the following configuration registers to zero:

- **REG 42237 – Grid Form Droop V/Q Proportional Gain**
- **REG 42239 – Grid Form Droop W/P Proportional Gain**
- **REG 42240 – Grid Form Virtual Inductance**
- **REG 42242 – Grid Form Virtual Resistance**

For systems where multiple PCS units are operated in parallel, or in conjunction with other distributed sources, Oztek recommends using the default droop gains and virtual impedances. If necessary, contact Oztek technical support to discuss systems that require changes from these default settings.

6.4 Changing Operating Modes

The PCS operating mode may be manually changed from Grid Tie to Grid Forming (and vice versa) using **REG 41747 – PCS Control Mode**. When using this register to change operating modes, the PCS must first be disabled. Otherwise, any attempt to change modes by writing to this register while the PCS is operating will be ignored.

The operating mode can also be controlled by using the optional Island Control digital input pin (DIN) - see section 4.2.3 for details on pin location and electrical requirements. **REG 42231 – Island Control Input Pin Configuration** is used to enable this pin, configure the input polarity as active high or active low, and to select *Passive* or *Seamless* mode changes as described below. When the Island Control pin is enabled, attempts to change the mode by writing to **REG 41747 – PCS Control Mode** will be ignored. However, this register may be read to indicate the present operating mode as determined by the hardware pin.

6.4.1 Passive Mode Changes

When configured for *Passive* mode changes, the state of the Island Control input pin is used to determine the mode based on the selected pin polarity. When this input pin changes state, the PCS is automatically turned off and transitioned to the **Disabled** state. Once in the **Disabled** state, the PCS will set **REG 41747 – PCS Control Mode** to the newly selected operating mode. At this point the user can then enable PCS operation as described in sections 6.2.1 and 6.3.1.

This mode may be useful for systems where an external resource is used to indicate that a mode change is necessary and to quickly disable all PCS's at the same time, but where additional action must be taken by the local system controller prior to re-enabling the PCS's in the new mode.

6.4.2 Seamless Mode Changes

When configured for *Seamless* mode changes, the Island Control input pin is used to seamlessly transition between Grid Tie and Grid Forming modes while the PCS is operating. In this configuration, an external utility interconnection relay is used to monitor the grid connection and to quickly disconnect the local microgrid under abnormal grid conditions and at the same time change the PCS operating mode to Grid Forming. The PCS remains enabled and continues to process power during this mode change. This same device is also used to determine when the grid has returned, and if it is safe to reconnect the local microgrid based on the voltage, frequency, and phase difference between the two being within specified tolerances. If so, it will then close the main grid interface contactor and automatically change the PCS operating mode back to Grid Tie.

See Oztek Application Note **AN-0003** “*OzPCS-RS40 Seamless Transfer System Configuration*” for an example system which implements seamless transfers, along with details on configuring the various PCS support registers and real-world test data.

6.5 Operating States

A state machine is used to provide deterministic control and sequencing of the PCS hardware. Figure 31 illustrates the operating states as well as the transition logic employed in the system state machine. Each state is described in further detail below. As Figure 31 illustrates, the PCS is disabled, and the power stage hardware will be inoperable until the PCS reaches the **Standby** state. Any attempts to turn the PCS on with **REG 41743 – Set Operation** will be ignored until the PCS reaches the **Standby** state.

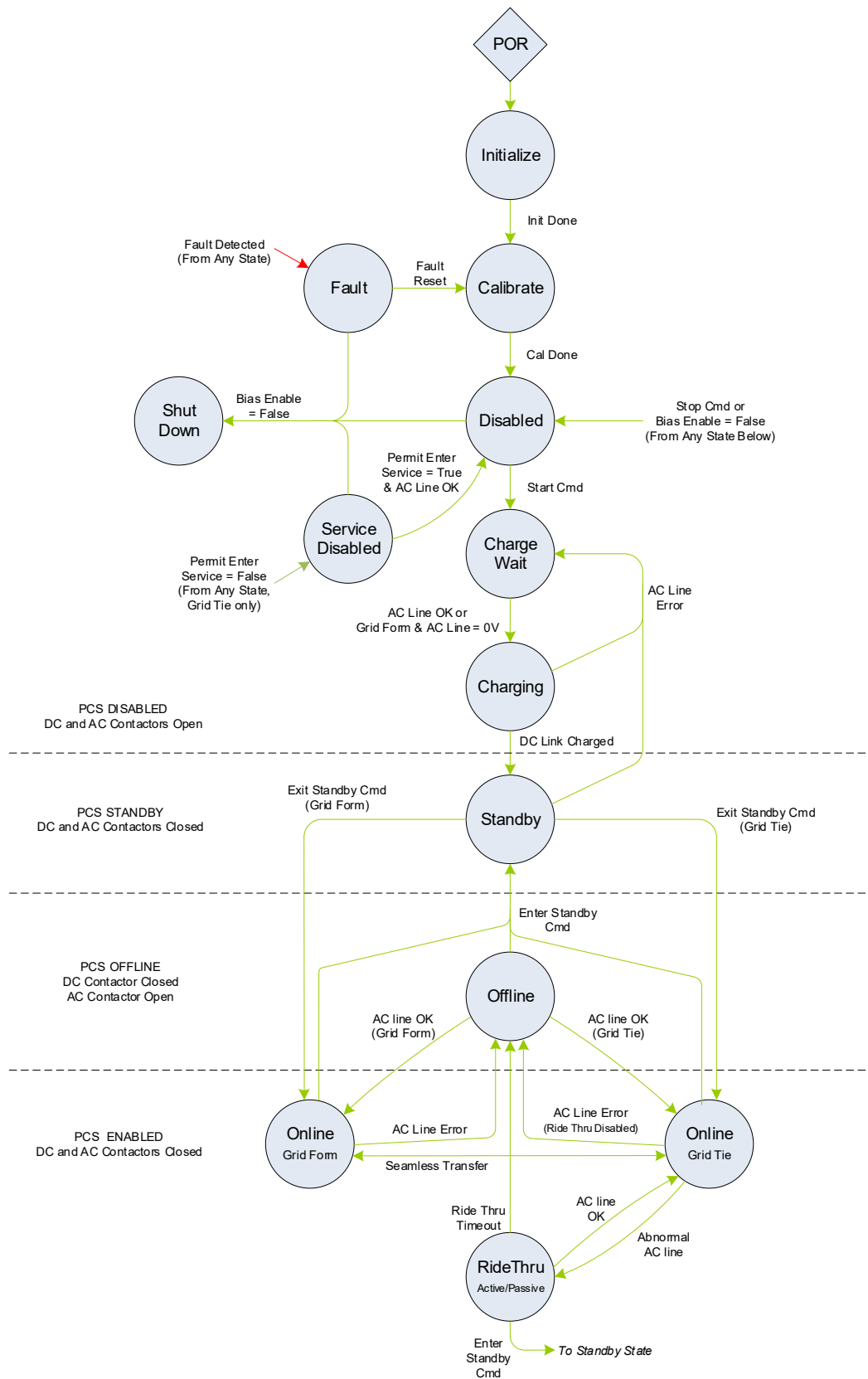

Figure 31 - PCS Control State Machine

6.5.1 Initialize

The state machine resets to the **Initialize** state following a power-on-reset (POR) event. The firmware is initializing hardware peripherals, configuring variables, and performing self-health tests while in this state. Upon successful initialization, the PCS will auto-transition to the **Calibrate** state.

6.5.2 Calibrate

The **Calibrate** state is used to perform calibration of internal sensors and inputs. Following successful calibration, the PCS will auto-transition to the **Disabled** state.

6.5.3 Disabled

When in the **Disabled** state, both the DC and AC contactors are open, and all power devices are off. The PCS will transition to the **Charge Wait** state after receiving a “Start” command (**REG 41743 – Set Operation = 1**) as long as the main E-Stop input is not active.

As the state diagram above indicates, once the PCS has been started and has proceeded past this state, a “Stop” command (**REG 41743 – Set Operation = 0**) or disabling the Bias Enable input pin will force the PCS to cease operation, open the AC and DC contactors, and transition back to this state.

6.5.4 Charge Wait

In the **Charge Wait** state, the PCS monitors the AC line terminals. When a valid AC line is detected based on the Enter Service voltage and frequency thresholds, **REG 40295 – 40299** for Grid Tie operation or **REG 42232 – 42235** for Grid Forming operation, the PCS will transition to the **Charging** state. Alternatively, if configured for Grid Forming operation and the AC line voltage is less than the maximum black start voltage (10 V_{RMS} line-to-line), the PCS will transition to the **Charging** state.

6.5.5 Charging

In the **Charging** state, the internal pre-charge circuitry is enabled, and the PCS waits until the internal DC link has been sufficiently charged. Once the DC link voltage has reached an acceptable level, the PCS will transition to the **Standby** state. During this transition, both the DC and AC contactors are closed. If the AC line is no longer valid while in the middle of the pre-charge process, charging will be terminated, and the PCS will transition back to the **Charge Wait** state.

For the internal pre-charge process to complete, the DC voltage must remain above the value specified in **REG 41877 – DC Under Voltage Fault Threshold** by approximately 5V or more. Otherwise, the pre-charge process is suspended, and the PCS will wait in this state until the

voltage rises above this level or falls below the fault threshold, causing the PCS to go to the **Fault** state.

6.5.6 Standby

Once in the **Standby** state the PCS is ready for use. An “Exit Standby” command (**REG 41743 – Set Operation = 3**) must be sent to turn on the PCS, at which point it will transition to the **Turn-On Delay** state and then to either **Online – Grid Tie** or **Online – Grid Form** state, depending on the selected operating mode. If the AC line is no longer valid while in the **Standby** state, the PCS will open the AC and DC contactors and transition back to the **Charge Wait** state.

6.5.7 Turn-On Delay

The **Turn-On Delay** state is used to indicate when the PCS is about to turn on but is waiting for a configurable delay before operating. This can occur when transitioning from the **Standby** state to one of the **Online** states if **REG 41823 – Initial Turn-On Window** is set to a value other than zero (except when black starting in Grid Forming mode). Once the configured delay time has expired, the PCS will transition from this state to one of the **Online** states based on the configured operating mode. For the sake of simplicity, this state is intentionally not shown in the state diagram above.

6.5.8 Online – Grid Tie

While in the **Online – Grid Tie** state, the PCS is connected to the grid and operating in Grid Tie mode, controlling the active and reactive grid power. If a fault occurs, the PCS will immediately turn OFF, open the AC and DC contactors, and transition to the **Fault** state.

If an abnormal grid condition is detected, the PCS will transition to either the **Offline** or **Ride Through** state, depending on configuration. Otherwise, the PCS will remain in this state indefinitely until an “Enter Standby” command (**REG 41743 – Set Operation = 2**) or a “Stop” command (**REG 41743 – Set Operation = 0**) is received.

The PCS may transition from this state to the **Online – Grid Form** state if seamless transfers are enabled and the Island Control input pin has commanded a mode change due to abnormal grid condition – see section 6.4.2 for more details.

6.5.9 Online – Grid Form

While in the **Online – Grid Form** state, the PCS is operating as an AC voltage source and actively regulating the AC output voltage and frequency. If a fault occurs, the PCS will immediately turn OFF, open the AC and DC contactors, and transition to the **Fault** state.

If the AC line falls outside of the voltage and frequency ranges specified in **REG 42232-42235**, the PCS will turn OFF, open the AC contactor, and transition to the **Offline** state. Otherwise, the

PCS will remain in this state indefinitely until an “Enter Standby” command (**REG 41743 – Set Operation = 2**) or a “Stop” command (**REG 41743 – Set Operation = 0**) is received.

The PCS may transition from this state to the **Online – Grid Tie** state if seamless transfers are enabled and the Island Control input pin has commanded a mode change due to the utility grid returning to acceptable conditions – see section 6.4.2 for more details.

6.5.10 Offline

While in the **Offline** state, the PCS has stopped processing power and the AC contactor is open. The PCS will monitor AC line conditions, and upon restoration, based on resume voltage and frequency thresholds (**REG 40295 – 40299** for Grid Tie operation, **REG 42244 – 42247** for Grid Forming operation), reconnect and sequence back to one of the **Online** states based on the selected operating mode.

Otherwise, the PCS will remain in this state until an “Enter Standby” command (**REG 41743 – Set Operation = 2**) or a “Stop” command (**REG 41743 – Set Operation = 0**) is received, the **Offline** duration exceeds the **REG 41825 – Auto-Resume Timeout** period, or a fault occurs.

6.5.11 Ride Through

The **Ride Through** state is only possible if the PCS is configured for Grid Tie mode and has detected abnormal grid conditions, namely low or high frequency and/or low or high voltage. The PCS behavior for each of these four conditions is configurable. See section 6.2.8 for configuration details. Note that the reported state will reflect the ride through condition, i.e. **Ride Through Active** (PCS is still operating) or **Ride Through Passive** (PCS has momentarily ceased to operate) as appropriate.

The PCS will remain in the **Ride Through** state until grid conditions return to normal and the PCS transitions back to the **Online – Grid Tie** state, or grid fault conditions occur and the PCS transitions to the **Offline** state. Otherwise, the PCS will remain in the **Ride Through** state unless an “Enter Standby” command (**REG 41743 – Set Operation = 2**) or a “Stop” command (**REG 41743 – Set Operation = 0**) is received.

6.5.12 Turn Off

When the PCS is operating in Grid Tie mode (i.e. in the **Online – Grid Tie** state) and is then turned off, it will transition to this state and begin ramping the AC current to zero at a rate defined in **REG 41830 – Grid-Tie Turn-Off Current Slew Rate**. The PCS will remain in this state until the AC current reaches zero. For the sake of simplicity, this state is intentionally not shown in the state diagram above.

6.5.13 Island Transfer Wait

If the PCS is configured to allow seamless transfers from Grid Tie to Grid Forming mode (see **REG 42231 – Island Control Input Pin Configuration**) and is operating in Grid Tie mode and is about to go **Offline** due to abnormal grid conditions, it will first transition to this state. The PCS waits in this state to see if the island control pin is about to command a mode change to Grid Forming mode. If this command doesn't occur within the time specified in **REG 42250 – Seamless Transfer Offline Timeout Delay**, the PCS will automatically transition to the **Offline** state. If the mode change command *does* occur before this timeout delay, the PCS will automatically switch over to Grid Forming mode and transition to the **Online – Grid Form** state.

If the mode change command doesn't occur and the grid conditions return to the normal operating range before the timeout delay, the PCS will remain in Grid Tie mode and will transition back to the **Online – Grid Tie** state.

This is short transitional state allows external controllers enough time to signal a mode change upon fast abnormal grid conditions. For the sake of simplicity, this state is intentionally not shown in the state diagram above.

6.5.14 Fault

If a fault is detected in any of the operating states, the power stage is immediately turned OFF, the AC and DC contactors are opened, and the PCS transitions to the **Fault** state. The PCS will remain in this state until the latched fault information is explicitly cleared using **REG 41742 – Fault Reset**. If any fault conditions still exist when the fault reset occurs, the PCS will remain in the **Fault** state. All attempts to enable or turn the PCS on are ignored while in the **Fault** state.

6.5.15 Service Disabled

If at any point **REG 40294 – Permit Enter Service** is set to "0" (*Disabled*) while configured for Grid Tie mode, the PCS will cease operation, open the AC and DC contactors, and transition to this state. If at POR this register is set to "0", the PCS will transition to this state after the **Initialize** and **Calibrate** functions have finished.

The PCS will remain in this state until service has been re-enabled by setting **REG 40294 – Permit Enter Service** to "1". Once re-enabled, the PCS waits for the grid to satisfy the Enter Service voltage and frequency requirements (**REG 40295-40299**), at which point the Enter Service delay times (**REG 40301-40303**) are enforced (see section 6.2.2 for details). After waiting for the required delay times, the PCS will transition to the **Disabled** state. If the PCS was previously enabled at the time that service was disabled and control power has not been cycled, the PCS will immediately transition out of the **Disabled** state and start the charging and reconnect process.

If the PCS mode is changed from Grid Tie to Grid Forming, the PCS will exit this state and transition to the **Disabled** state – i.e. Permit Enter Service is only enforced in Grid Tie mode.

6.5.16 Shutdown

The **Shutdown** state is entered whenever the Bias On/Off discrete input (section 5.2.2.2), is de-asserted. While in the **Shutdown** state, the PCS performs various housekeeping tasks before finally disabling the bias supply and shutting itself down.

If the PCS happens to be operating, or in any state other than **Fault**, **Disabled**, or **Service Disabled** when the Bias On/Off input is de-asserted, the system will automatically sequence to **Disabled** before transitioning to **Shutdown**.

7. Fault and Warning Conditions

The PCS provides warning indicators and fault protection in the event of conditions that may cause damage to the equipment or injure personnel. The following sections describe each of the conditions monitored by the PCS.

7.1 Warnings

The PCS provides the warning indicators listed below. These warning flags do not prohibit operation, and will self-clear, requiring no user intervention. They are reported for informational purposes only. Each warning flag described below is reported in **REG 41756 – PCS Warning Status**. The PCS can also indicate a warning by asserting an isolated output signal. See section 5.2.3 for details on how to configure the isolated outputs.

7.1.1 High Inverter Current – Phase A, B, C

The PCS monitors the RMS inverter currents for each of the three phases and will set a flag (one per phase) if the current exceeds the threshold specified by **REG 41872 – AC Over Current Warning Threshold**. These flags will remain set until the respective current falls below the warning threshold less **REG 41873 – AC Over Current Warning Recover Delta**.

7.1.2 High Grid Voltage

The PCS monitors the three RMS phase-to-phase AC line voltages and will set a warning flag (one per phase-to-phase voltage) if the voltage exceeds the threshold specified by **REG 41875 – AC Over Voltage Warning Threshold**. These flags will remain set until the respective voltage falls below the warning threshold less **REG 41876 – AC Over Voltage Warning Recover Delta**.

7.1.3 PLL Not Locked

The PCS monitors the status of the internal phase lock loop (PLL) module that provides synchronization to the AC line and will set a warning flag if the PLL is not locked. This flag is cleared when the PLL regains lock.

7.1.4 Loss of Phase

The PCS monitors the zero crossings for each of the three AC line voltages and will set this warning flag any time a zero crossing does not occur on one or more of the three phases within the period specified by **REG 41818 – Nominal AC Frequency Setting**.

7.1.5 AC Current Limit

The PCS will limit the AC output current to the value specified by **REG 40281 – Setting for Maximum AC Current**. When operating in Grid Tie mode, the PCS will actively clamp the AC current to this value and will set this warning bit any time the current is being limited. When operating in Grid Forming mode, dynamic virtual impedance is used to attempt to limit the output current, and this warning bit will be set to indicate that this virtual impedance is being used.

7.1.6 DC Power Limit

At lower DC voltages, the power capability of the PCS is limited by the **Maximum DC Charge/Discharge Current** ratings, **REG 41748-41749**. When operating in Grid Tie mode under these conditions the PCS actively limits the active AC power to keep from exceeding the DC current rating, and this bit is set. The bit is cleared when the AC power is no longer limited.

When operating in Grid Forming mode, this warning bit is set any time the available DC power is less than the rated power, indicating that the PCS may not be able to operate under maximum rated load conditions.

7.1.7 AC Power Limit

This bit is set when operating in Grid Tie mode and the combined active and reactive power commands exceed the continuous volt-ampere capability specified in **REG 40271**. Under these conditions, the PCS will actively limit the power using the priority scheme configured for the selected reactive power controller (see section 6.2.4 “Reactive Power Control” for details).

This bit is also set when operating in Power Factor Mode (**REG 40313/40319 – Power Factor Enable – Injecting/Absorbing Watts** = 1) and the calculated reactive power command exceeds the maximum reactive power setpoint configured in **REG 40272/40273**.

7.1.8 AC Current Overload

Regardless of operating mode (Grid Tie or Grid Forming), the PCS attempts to avoid fast over-current trip events by employing a cycle-by-cycle current limiting technique that turns off the inverter’s switching outputs on a per-PWM period basis whenever the AC phase currents exceed the hardware capability. This warning bit will be set and remain on for roughly 1 second any time one of these fast limit events occur. This feature is meant to avoid tripping due to very fast load transient events, i.e. for only a few line cycles. Overload events that persist for several

line cycles or longer will result in hardware over-current faults and will cause the PCS to immediately turn off, disconnect, and transition to the **Fault** state.

7.1.9 Grid Out of Tolerance (OOT)

This bit is set whenever the PCS is offline due to the grid being out of tolerance, as defined in section 6.2.2.

7.1.10 Resume – Delay

This bit is set during the *Enter Service* time delay of a PCS reconnection attempt, as defined in section 6.2.2.

7.1.11 Island Detected

This bit is set when an island condition is detected and anti-islanding is enabled in **REG 40363 – Anti-Islanding Enable** and **REG 41828 – Anti-Island Detector Mode Select** is set to 1 = “Enabled – Keep Running on Island Detect” or 3 = “Auto Resume”.

7.1.12 High DC Current

The PCS will set a flag if the DC current exceeds the threshold specified by **REG 41899 – DC Over Current Warning Threshold**. This flag will remain set until the DC current falls below the warning threshold less **REG 41900 – DC Over Current Warning Recover Delta**.

7.1.13 Temperature Warning

The PCS monitors several internal temperature sensors and will set this warning bit under various high and low temperature conditions. When this warning bit is set, **REG 41764 – Temperature Status** can be read to determine the source of the warning condition(s). Possible warning conditions are:

- **High Heatsink Temperatures** (DC/DC or Inverter)
- **High Temperature Imbalance Between Heatsinks** (DC/DC or Inverter)
- **High Estimated IGBT Temperatures** (DC/DC or Inverter)
- **High Cabinet Temperature**

The thresholds for the temperature warnings listed above are set by the factory and are not configurable by the user. In general, these thresholds are chosen to indicate that the associated condition is within approximately 5 °C to 10 °C of the fault threshold for the corresponding event.

7.1.14 Low DC Voltage

The PCS sets this flag if the DC voltage falls below the threshold specified by **REG 41878 – DC Under Voltage Warning Threshold**. The flag will remain set until the voltage rises above the warning threshold plus **REG 41879 – DC Under Voltage Warning Recover Delta**.

7.1.15 High DC Voltage

The PCS sets this flag if the DC voltage exceeds the threshold specified by **REG 41881 – DC Over Voltage Warning Threshold**. The flag will remain set until the voltage falls below the warning threshold less **REG 41882 – DC Over Voltage Warning Recover Delta**.

7.1.16 Fan Warning

The PCS monitors tachometer feedback from the cooling fans and will report this warning if the fans are not operating as expected. When this bit is set, **REG 41766 – Fan Status** can be read to determine which fan is not spinning properly. This warning will remain set, even after the fans have been turned off. Only the successful operation of the fans will clear this bit.

7.1.17 HVRT Active Override

The PCS can only provide active ride through capability if the line voltage is below the “Active Ride Through V_{MAX} ” specification (see section 2.2 “Electrical Specifications”). If the user configures one of the High Voltage Ride Through Momentary Cessation regions with a voltage that exceeds this specification, the voltage threshold for that region of the curve will be forced to the maximum allowable value and this warning bit is set. Similarly, if the High Voltage Ride Through Momentary Cessation function is not enabled, then a default curve with a threshold set to the “Maximum Active Ride Through Voltage” and a duration of zero will be used and this bit will be set.

7.1.18 TVS Error

The PCS uses an AC filter when connected to the AC line voltage. This filter contains transient voltage suppression (TVS) devices to protect the converter from voltage spikes that may occur on the AC terminals. The PCS monitors the health of these TVS devices to ensure that they are still working properly. This warning bit will be set and remain latched if one or more of the TVS devices appear to be damaged. This bit may only be cleared by cycling the PCS bias power.

7.1.19 Volt-VAR Active

This warning flag is asserted any time the Volt-VAR grid support function is enabled and is presently forcing a non-zero reactive power command due to a grid over or under-voltage condition.

7.1.20 Watt-VAR Active

This warning flag is asserted any time the Watt-VAR grid support function is enabled and is presently forcing a non-zero reactive power command in response to the PCS’s active output power.

7.1.21 Volt-Watt Active

This warning flag is asserted any time the Volt-Watt grid support function is enabled and is presently clamping the user’s active power command due to a grid over-voltage condition.

7.1.22 Frequency-Watt Active

This warning flag is asserted any time the Frequency Droop grid support function is enabled and is presently overriding the user's active power command due to a grid over or under-frequency condition.

7.1.23 Limit Active Power

This warning flag is asserted any time **REG 40325 – Limit Max Active Power Percent Enable** = 1 and the user's active power command is being clamped to the value specified in **REG 40326 – Limit Max Active Power Percent Setpoint**.

7.1.24 Negative Sequence Current Limit

This warning flag is asserted when **REG 41831 – Voltage Unbalance Control Enable** = 1 and the negative sequence current command from the voltage unbalance controller is being clamped based on the positive sequence operating current to not exceed the PCS's AC current rating. See section 6.2.6 for further details.

7.2 Faults

The PCS provides the fault detection listed below. Whenever a fault occurs the PCS will automatically turn the power stage hardware OFF, open both DC and AC contactors, and transition to the **Fault** state. Any attempt to turn the PCS ON while it is in the **Fault** state will be ignored.

Each fault condition is latched and reported in **REG 41758 – PCS Fault Status**. The PCS can also indicate the presence of a fault condition by asserting an isolated output signal any time one or more latched fault bits are present. See section 5.2.3 for details on how to configure the isolated outputs.

The PCS will remain in the **Fault** state and any latched fault flags remain set until explicitly cleared using **REG 41742 – Fault Reset**. Upon receiving the fault reset command, the PCS will attempt to clear all latched fault bits. If the faults are successfully cleared, the PCS will transition back to the **Calibrate** state and then to the **Disabled** state. If any faults fail to clear, the respective fault bits will remain latched, and the PCS will remain in the **Fault** state.

7.2.1 H/W and S/W Inverter Over-Current A, B, C

The PCS provides fast hardware protection for inverter over current conditions. It also monitors the RMS inverter currents for each of the three phases and will fault if any of the currents exceed the threshold specified by **REG 41871 – AC Over Current Fault Threshold**.

When operating in Grid Tie mode, the RMS over-current fault occurs immediately whenever the threshold is exceeded. When operating in Grid Forming mode, the RMS over-current event is

timer-based, and this fault will occur if the current exceeds the threshold for more than 5 seconds.

7.2.2 AC Over-Voltage AB, BC, CA

The PCS monitors the AC RMS line-to-line voltage for phases AB, BC, and CA, and will fault if any of the voltages exceed the threshold specified by **REG 41874 – AC Over Voltage Fault Threshold** while the AC contactor is closed.

7.2.3 Ride Through – Low/High Voltage/Frequency

When operating in Grid Tie mode and a trip condition occurs following a ride through event, LVRT, HVRT, LFRT, or HFRT, the PCS will go **Offline** and wait for the grid to recover. Once recovered, the PCS will automatically resume operation. **REG 41825 – Auto-Resume Timeout** sets the maximum allowable time to wait for the grid to recover. Once this timeout has expired, the PCS will disable itself and transition to the **Fault** state. Upon transition, the fault bit corresponding to the ride through event that initiated the PCS going **Offline** is set.

7.2.4 Grid Island Condition

This bit is set when an island condition is detected and anti-islanding is enabled in **REG 40363 – Anti-Islanding Enable** and **REG 41828 – Anti-Island Detector Mode Select** is set to 2, “*Fault on Island Detect*”.

7.2.5 Emergency Stop

The PCS will assert a fault if the ESTOP hardware input is not actively driven.

7.2.6 Communications Heartbeat Fault

The PCS expects the system controller to write to **REG 41740 – Controller Heartbeat** at regular intervals with a value equal to the previous value plus ‘1’ or reset back to ‘0’ at any time. The PCS will monitor the Controller Heartbeat register and assert this fault if it hasn’t incremented by 1, or been reset to zero, within a period specified in **REG 41836 – Communications Heartbeat Timeout**.

Writing the same value in back-to-back writes is allowed but will not reset the timer. This allows the host to retry any failed write attempts, but the timeout monitor will still require an incrementing value within the timeout period.

This heartbeat fault checking is not armed until the first write to the Controller Heartbeat register occurs following a POR.

7.2.7 Power Down Error

This fault bit is set if the PCS fails to power down when the “Bias On/Off” discrete input is de-asserted.

7.2.8 Invalid User Configuration

This bit indicates that the User has set an invalid configuration register or combination of registers. If this bit is set, see **REG 41762 – User Configuration Error Status** to determine the offending register(s).

7.2.9 Invalid Model

This bit is set if the loaded product configuration is not compatible with the PCS Model. Please consult Oztek for the proper configuration file.

7.2.10 H/W and S/W DC Over-Voltage

The PCS provides fast hardware protection for DC over-voltage conditions. It also monitors the DC voltage and will fault if it exceeds the threshold specified by **REG 41880 – DC Over Voltage Fault Threshold**.

7.2.11 DC Over-Current

The PCS monitors the DC current and will fault if it exceeds the threshold specified by **REG 41898 – DC Over Current Fault Threshold**.

7.2.12 DC Under-Voltage

The PCS monitors the DC voltage and will fault if it falls below the threshold specified by **REG 41877 – DC Under Voltage Fault Threshold**.

7.2.13 Temperature Faults

This bit is set if one or more of the internal temperature sensors in the PCS reaches the associated factory fault threshold. **REG 41764 – Temperature Status** can be read to determine the source(s) of the temperature fault. Possible temperature fault conditions are:

- **Heatsink Over Temp** (DC/DC or Inverter)
- **Temperature Imbalance Between Heatsinks** (DC/DC or Inverter)
- **Estimated IGBT Over Temp** (DC/DC or Inverter)
- **Cabinet Over Temp**

The thresholds for the temperature faults listed above are set by the factory and are not configurable by the user.

7.2.14 Saturation Error A, B, C

These fault bits indicate that the inverter control output for the respective phase has saturated and that the inverter is no longer able to regulate the output.

7.2.15 AC Current Overload Trip

As described in section 7.1.8, the PCS uses a fast cycle-by-cycle current limiting technique that turns off the inverter's switching outputs on a per-PWM period basis whenever the AC phase currents exceed the hardware capability. This feature is meant to avoid over-current trip events due to very fast load transient events, i.e. for only a few line cycles. Overload events that persist for several line cycles or longer (approximately 100ms) will result in this fault bit being set.

7.2.16 Internal Factory Fault

This bit is set any time one or more internal factory faults occur in the PCS. **REG 41760 – Factory Fault Status** can be read to determine the source of the offending fault(s). In general, these factory fault conditions are related to circuitry internal to the PCS and should rarely occur unless there are hardware failures within the PCS or if very abnormal conditions occur outside the PCS. If the PCS is consistently reporting any of these conditions, contact Oztek technical support to discuss the appropriate course of action. Each of the factory faults is briefly described below in order to assist in this discussion.

- **H/W and S/W DC Over-Current (A/B/C, top/bot)** – The PCS uses a multi-phase DC/DC converter to boost the DC input voltage up to the desired internal DC link voltage used by the inverter. These fault bits are used to indicate over-current conditions within the DC/DC converter phases.
- **DC Current Imbalance (A/B/C)** – These bits are used to indicate an imbalance condition within the three DC/DC converter phases.
- **DC Link Over Voltage (H/W top/bot and S/W)** – The PCS provides hardware-based over voltage protection for each internal DC link voltage (top and bottom), as well as software-based protection for the total combined link voltage. These bits are set any time one of these over voltage conditions occur.
- **DC Link Voltage Imbalance** – This fault occurs if the difference between the top and bottom DC Link voltages exceed the maximum imbalance threshold.
- **Pre-Charge Timeout** – The PCS contains active circuitry to charge the internal DC link voltage above the DC input voltage prior to closing the DC input contactor (i.e. while the PCS is in the **Charging** state). If the DC link voltage fails to charge within the expected timeframe, the pre-charge operation will be terminated, and this fault bit will be set.
- **Bias Under Voltage** – The PCS generates its internal control bias supply from the DC input voltage. If this internal bias supply ever drops below the minimum operating voltage, this fault bit will be set.
- **Contactor Interlock** – Under normal operating conditions, the internal DC link voltage in the PCS will always be higher than the rectified AC line voltage prior to closing the AC

contactor. If the rectified line voltage is higher than the internal link voltage when attempting to close the AC contactor, large inrush currents and/or a DC link over-voltage could occur. The PCS's AC contactor controls will prevent closing the AC contactor under these conditions and will set this fault bit to indicate that this has occurred.

- **DC/DC Communication Error** – This fault bit will be set if any internal communications errors occur.
- **Datalog Error** – Datalogging information (discussed in section 9) is stored in non-volatile FLASH memory on the PCS controller. This fault bit is set whenever the PCS experiences an error when updating this FLASH memory, indicating possible corruption or loss of datalogging information.
- **Invalid Factory Configuration** – The PCS controller uses a non-volatile memory device for storing factory information specific to each unit, such as serial number and model information. This fault bit is set whenever the PCS experiences an error when reading or writing this memory, indicating the possible corruption of the factory information.
- **Configuration EEPROM Error** – This fault bit is set whenever the PCS experiences an error when reading or writing configuration memory, indicating the possible corruption of the configuration settings.
- **Calibration Error** – Following a power-on reset, the PCS will perform a self-calibration of various internal sensors. This bit will be set if the calibration correction for one or more of the sensors exceeds the maximum expected limits, indicating that one or more of the hardware sense circuits may be damaged.

8. Real Time Clock (RTC)

The PCS provides a real-time clock (RTC) function to allow recording elapsed times as well as time stamping data log values.



CAUTION

The RTC needs to be set each time the PCS is powered on. Prior to each shutdown, the present time and date is stored in non-volatile memory. Upon a POR, the RTC will resume time/date keeping from this point until it is set by the user. See section 8.3 for information on setting the date and time.

8.1 Real Time Clock – Date Format

The RTC date is stored as a 32-bit data word with the following format:

Bits 31 - 24	Bit 23 – 16	Bit 15 - 14	Bit 13 - 0
Day	Month	n/a	Year

8.2 Real Time Clock – Time Format

The RTC clock time is stored as a 32-bit data word with the following format:

Bits 31 - 24	Bit 23 – 16	Bit 15 - 8	Bit 7 - 0
n/a	seconds	minutes	hours

8.3 Setting the Date and Time

For synchronization purposes, the data and time must always be set together. **REG 42085 – RTC Set Date** must be written first, followed by a write to **REG 42087 – RTC Set Time**. See section 11.3.22 for register details.

8.4 Reading the Date and Time

For synchronization purposes, the data and time must always be read together. **REG 42089 – RTC Get Date** must be read first, followed by a read of **REG 42091 – RTC Get Time**. See section 11.3.22 for register details.

9. Data Logging

The PCS provides three types of data logging activities as described in the following paragraphs. Event Data Logging captures operating parameters on a fault or user configured trigger event. Fault History Logs provide time stamp and event counters for each fault source. Operating History Logs provide cumulative time spent operating under a variety of conditions as well as min/max values for critical parameters.

9.1 Event Data Logging

The Event Data logging feature is intended to capture operating data leading up to, and shortly after an event. Events can be the assertion of a system fault or a user configured “trigger” event. For a detailed explanation of data types, please see sections 11.1.3 - 11.1.9.

Table 12 - Data Logging Parameters

Param #	Data Log Buffer Address	Buffer Offset	Data Type	Parameter	Units
0	42132	0	U16	PCS State	ENUM
1	42133-42134	1	U32	PCS Faults	Bitfield
2	42135-42136	3	U32	PCS Warnings	Bitfield
3	42137	5	U16	DC Voltage	0.1 V
4	42138	6	S16	DC Current	0.1 A
5	42139	7	U16	RMS Voltage – Phase AB	0.1 V _{RMS}
6	42140	8	U16	RMS Voltage – Phase BC	0.1 V _{RMS}
7	42141	9	U16	RMS Voltage – Phase CA	0.1 V _{RMS}
8	42142	10	U16	RMS Voltage – Phase A	0.1 V _{RMS}
9	42143	11	U16	RMS Voltage – Phase B	0.1 V _{RMS}
10	42144	12	U16	RMS Voltage – Phase C	0.1 V _{RMS}
11	42445	13	U16	RMS Grid Current – Phase A	0.1 A _{RMS}
12	42146	14	U16	RMS Grid Current – Phase B	0.1 A _{RMS}
13	42147	15	U16	RMS Grid Current – Phase C	0.1 A _{RMS}
14	42148	16	S16	Grid Current – Phase A (instantaneous)	0.1 A
15	42149	17	S16	Grid Current – Phase B (instantaneous)	0.1 A
16	42150	18	S16	Grid Current – Phase C (instantaneous)	0.1 A
17	42151	19	S16	AC Active Power – P	10 W
18	42152	20	S16	AC Reactive Power – Q	10 VAR
19	42153-42154	21	U32	AC Frequency	0.001 Hz
20	42155	23	S16	AC Power Factor	0.001
21	42156	24	S16	DC/DC Heatsink Temp – Phase A	°C
22	42157	25	S16	DC/DC Heatsink Temp – Phase B	°C
23	42158	26	S16	DC/DC Heatsink Temp – Phase C	°C
24	42159	27	S16	Inverter Heatsink Temp – Phase A	°C
25	42160	28	S16	Inverter Heatsink Temp – Phase B	°C
26	42161	29	S16	Inverter Heatsink Temp – Phase C	°C
27	42162	30	S16	DC/DC Estimated IGBT Temp	°C
28	42163	31	S16	Inverter Estimated IGBT Temp	°C
29	42164	32	S16	Cabinet Temp	°C
30	42165	33	S16	Ambient Temp (<i>not supported, returns 0</i>)	°C
31	42166	34	S16	Command – Grid Active Power P	10 W
32	42167	35	S16	Command – Grid Reactive Power Q	10 VAR
33	42168	36	S16	Command – Grid Active Current D	0.1 A
34	42169	37	S16	Command – Grid Reactive Current Q	0.1 A
35	42170	38	S16	Measured Grid Active Current D	0.1 A
36	42171	39	S16	Measured Grid Reactive Current Q	0.1 A
37	42172	40	S16	Measured Grid Voltage – D	0.1 V
38	42173	41	S16	Measured Grid Voltage – Q	0.1 V
39	42174	42	U16	RMS Inverter Current – Phase A	0.1 A _{RMS}
40	42175	43	U16	RMS Inverter Current – Phase B	0.1 A _{RMS}
41	42176	44	U16	RMS Inverter Current – Phase C	0.1 A _{RMS}
42	42177	45	S16	Grid Inverter Active Current D	0.1 A

Param #	Data Log Buffer Address	Buffer Offset	Data Type	Parameter	Units
43	42178	46	S16	Grid Inverter Reactive Current Q	0.1 A
44	42179	47	S16	Inverter Output Voltage – D	0.1 V
45	42180	48	S16	Inverter Output Voltage – Q	0.1 V
46	42181	49	S16	DC Current – Top A	0.1 A
47	42182	50	S16	DC Current – Top B	0.1 A
48	42183	51	S16	DC Current – Top C	0.1 A
49	42184	52	S16	DC Current – Bottom A	0.1 A
50	42185	53	S16	DC Current – Bottom B	0.1 A
51	42186	54	S16	DC Current – Bottom C	0.1 A
52	42187	55	S16	Command – DC Current	0.1 A
53	42188	56	U16	DC Link Voltage	0.1 V
54	42189	57	U16	DC Link Voltage – Top	0.1 V
55	42190	58	U16	DC Link Voltage – Bottom	0.1 V
56	42191	59	S16	Anti-Island Power Adjust	0.01 %
57	42192	60	U16	Bias Voltage	0.01 V
58	42193-42194	61	U32	Factory Faults	Bitfield
59	42195-42196	63	U32	DC/DC Warnings	Bitfield
60	42197	65	U16	DC/DC State	ENUM

9.1.1 Fault Events

The data logging parameters defined in Table 12 are sampled at the factory configured rate defined in **REG 42093 – Fault Log Sample Period** and continuously buffered to RAM. When a fault event occurs, additional post-fault data is collected, after which the buffer is frozen and written to non-volatile memory. The PCS can store up to 12 fault logs. The fault log buffers are circular, such that a new fault event will cause the oldest fault log buffer to be overwritten with the new data.

To read the fault logs, the user should first read **REG 42094 – Fault Log Number of Available Logs** to determine how many fault logs contain valid data. Assuming one or more logs are valid, the user would then select the desired log to be read by writing to **REG 42097 – Fault Log Select**. Note that this register is 0-based, where 0 corresponds to the oldest fault event and 11 to the newest. For example, if **REG 42094** = 4, there are 4 available logs; to read the oldest set **REG 42097** = 0.

Once the desired log has been selected, the header information can be read by writing a “1” to **REG 42098 – Fault Log Get Header**, followed by a read of **Data Log Buffer Registers 42132 – 42139**. Table 13 defines the header data and format as read from the Data log buffer registers along with example data.

Table 13 - Fault Log Header Data Description

Data Log Read Buffer Address	Header Data Description	Example	Notes
42132	Time Stamp (MSW)	0x0000	e.g. = 1:48pm, see section 8.2 for details on time format.
42133	Time Stamp (LSW)	0x300D	
42134	Date Stamp (MSW)	0x1503	e.g. = 3/21/2017, see section 8.1 for details on date format.
42135	Date Stamp (LSW)	0x07E1	
42136	Sample Record Count	3223	
42137	Words per Record	66	
42138	Sample Period (ms)	1	Time between each record
42139	# of Post Trigger Samples	64	

In this example, the fault occurred at 1:48pm on 3/2/2017. There are 3,223 sample records, each containing 66, 16-bit words. The sample records were logged at 1ms intervals, and the last 64 records were logged after the fault occurred. Table 14 illustrates how this example buffer is organized.

Table 14 - Fault Log Buffer Organization

		Data Log Read Buffer Address			
		42132	42197	
		Parameter			
		PCS State	DC/DC State	Time
Pre-Fault Data →	Record 0	PCS State ₀	DC/DC State ₀	-3.158 sec
	Record 1	PCS State ₁	DC/DC State ₁	-3.157 sec
	
Fault Occurred →	Record 3158	PCS State ₃₁₅₈	DC/DC State ₃₁₅₈	0.000 sec
Post-Fault Data →	Record 3159	PCS State ₃₁₅₉	DC/DC State ₃₁₅₉	0.001 sec
	
	Record 3222	PCS State ₃₂₂₂	DC/DC State ₃₂₂₂	0.064 sec

With the header information, it is now possible to read as much or as little of the Fault Log as desired. Each record in the buffer is read individually by first writing the record number to **REG 42099 - Fault Log Get Selected Record**, and then reading the selected data from the corresponding **Data Log Buffer Registers**.

9.1.2 User Events

User Event data logging is intended to capture operating data leading up to and/or after a configurable trigger event. The data logging parameters defined in Table 12 are available for capture. The selected parameters are sampled at the user configured sampling rate and continuously buffered to RAM. When a trigger event occurs, the buffer is frozen or filled, depending on the configuration.

9.1.2.1 Selecting Parameters

The user may select one or more of the data logging parameters defined in Table 12 by writing to **REG 42104/42106 - User Log Variable Selection (LSW/MSW)**. These are two 32-bit registers where each bit can be considered an “enable” for the corresponding parameter in Table 12. The LSW register contains enable bits 0 – 31. The MSW register contains enable bits 32 – 63. Writing a “1” to specific bit positions indicates that the corresponding parameters will be captured.

Table 15 - User Log Variable Selection Bit Assignment

Bit	Parameter Name
0	PCS State
1	PCS Faults
⋮	⋮
59	DC/DC Warnings
60	DC/DC State
61 - 63	Reserved for Future Use

As an example, if the user wished to capture PCS Faults, the DC Voltage, and the DC Current they would write 0x0000001A to register 42104, and to capture Inverter Current Phase A, DC Current Top A, and DC Link Voltage they would write 0x00204080 to register 42106.

9.1.2.2 Setting the Sample Period and Post Trigger Size

The user can set the sample period by writing to **REG 42103 - User Log Sample Period**. Note that the User Event Log is fixed at 63,744 words. As a result, the number and size of the selected parameters, together with the sample period, will define the time duration of the captured data according to:

$$Duration = \frac{63,744 \text{ words}}{K \text{ words/sample}} \times SamplePeriod$$

As an example, assume **REG 42104 - User Log Variable Selection (LSW)** = 0x0000001A to log PCS Faults, the DC Voltage, and the DC Current. Referencing Table 12, the number of words per sample, K, would be 4 since DC Voltage and Current are U16 parameters and PCS Faults is a U32.

If **REG 42103 - User Log Sample Period** = 10msec, then 159.36 seconds worth of data will be captured. If a 1 second sample period were used instead, then 4 hours, 25 min, and 36 secs of data would be captured.

The user can also configure how much of the log is dedicated to post trigger information using **REG 42102- User Log Post Trigger Percentage**. This register is in units of %, so setting it to 0 would mean the entire log represents the time before the trigger event. A setting of 50% would mean half of the log occurred before the trigger and half after, while 100% implies all the log occurred after the trigger.

9.1.2.3 Configuring the Trigger Mode

The PCS supports four trigger modes, as described below, by setting **REG 42108 - User Log Trigger Mode** accordingly.

- | | |
|-----------------------------------|---|
| Mode 0: Continuous Trigger | Sampling is only controlled by REG 42101 - User Log Start/Stop . When register 42101 = 1, the selected parameters will be continuously sampled at the configured rate. The buffer is circular, so once filled, the oldest data will be overwritten with the latest sample. |
| Mode 1: Single Trigger | Sampling is controlled by REG 42101 - User Log Start/Stop as well as Trigger 1. Register 42101 must equal 1 and the Trigger 1 conditions must be True for the trigger to be asserted. |
| Mode 2: Dual OR Trigger | Sampling is controlled by REG 42101 - User Log Start/Stop as well as both Trigger 1 and 2. Register 42101 must equal 1 and either Trigger 1 conditions OR Trigger 2 conditions must be True for the trigger to be asserted. |
| Mode 3: Dual AND Trigger | Sampling is controlled by REG 42101 - User Log Start/Stop as well as both Trigger 1 and 2. Register 42101 must equal 1 and both Trigger 1 conditions AND Trigger 2 conditions must be True for the trigger to be asserted. |

9.1.2.4 Configuring Triggers

The PCS provides two user triggers. When configured for Single Trigger mode only Trigger 1 is used. Dual OR and Dual AND modes require both Trigger 1 and Trigger 2. Each trigger is configured by first selecting a parameter to trigger off. This is done using **REG 42110(42116) - User Log Trigger1(2) Variable Selection**. The value written to these registers corresponds to the parameter number in Table 12. For example, to trigger off the PCS Faults, the register should be set to "1". To trigger off DC Voltage the register should be set to "3".

The value in **REG 42111(42117) - User Log Trigger1(2) Value Mask** is bitwise AND'ed with the selected variable. The main purpose of this register is to allow selection of a bit within a bitfield register as the trigger source. For example, the H/W DC Over Voltage fault is bit 10 of the PCS Faults Status register. To use this bit as a trigger source, the mask register would be set to 0x00000400. See **REG 41756/41758 – PCS Warning/Fault Status** for a complete list of the various warning and fault bits and their corresponding register bit positions. Note that the mask is always applied and should be set to 0xFFFFFFFF if no masking is required.

To generate the trigger condition, the PCS compares the value of the masked, selected parameter to **REG 42113(42119) - User Log Trigger1(2) Trigger Value**. **REG 42109(42115) - User Log Trigger1(2) Compare Type** defines the type of comparison to be used as follows:

0 =	Less than (<)	Masked Parameter < Register 42113(42119)
1 =	Greater Than (>)	Masked Parameter > Register 42113 (42119)
2 =	Equal to (=)	Masked Parameter = Register 42113 (42119)
3 =	Not Equal to (!=)	Masked Parameter != Register 42113 (42119)

As an example, to trigger on the H/W DC Over Voltage Fault bit being asserted OR the DC Voltage being greater than 600V, the following register settings would be used:

Table 16 - User Log Trigger Configuration Example

Reg #	Reg Name	Value	Description
42108	Trigger Mode	2	Dual OR Trigger
42110	Trigger1 Variable Selection	1	PCS Faults
42111	Trigger1 Value Mask	0x00000400	Select H/W DC Over Voltage Fault bit
42109	Trigger1 Compare Type	2	Equal to
42113	Trigger1 Trigger Value	0x00000400	H/W DC Over Voltage Fault bit asserted
42116	Trigger2 Variable Selection	3	DC Voltage
42117	Trigger2 Value Mask	0xFFFFFFFF	No masking
42115	Trigger2 Compare Type	1	Greater than
42119	Trigger2 Trigger Value	6000	600V with 0.1V scaling

9.1.2.5 Reading the Log

REG 42121 – User Log Status can be read to determine the status of the logger. A value of 1 or 2 means the logger is either waiting for a trigger or in the middle of capturing data. A value of 3 means the logger has finished capturing data and it is available to be read.

To read the log, the user should first read the header information by writing a “1” to **REG 42122 – User Log Get Header**, followed by a read of **Data Log Buffer Registers 42132 – 42143**. Table 17 defines the header data and format as read from the Data Log Buffer Registers along with example data.

Table 17 - User Log Header Data Description

Data Log Read Buffer Address	Header Data Description	Example	Notes
42132	Time Stamp (MSW)	0x0000	e.g. = 1:48pm, see section 8.2 for details on time format.
42133	Time Stamp (LSW)	0x300D	
42134	Date Stamp (MSW)	0x1503	e.g. = 3/21/2017, see section 8.1 for details on date format.
42135	Date Stamp (LSW)	0x07E1	
42136	Selected User Vars - bits [31:16]	0x0000	PCS Faults, DC Voltage, DC Current selected
42137	Selected User Vars - bits [15:0]	0x001A	
42138	Selected User Vars - bits [63:48]	0	No variables selected
42139	Selected User Vars - bits [47:32]	0	
42140	Sample Count	15,936	
42141	Words per Sample	4	
42142	Sample Period (ms)	10	Time between each record
42143	# of Post Trigger Samples	3,984	

In this example, the trigger occurred at 1:48pm on 3/2/2017. There are 15,936 samples, each containing 4, 16-bit words. The samples were logged at 10ms intervals, and the last 3,984 samples were taken after the trigger occurred. Table 14 illustrates how this example buffer is organized.

Table 18 - User Log Buffer Organization

		Data Log Read Buff Address			Time
		42132 - 42133	42134	42135	
		Parameter			
		PCS Fault	DC Voltage	DC Current	
Pre-Trigger Data →	Sample 0	PCS Fault ₀	DC Volt ₀	DC Curr ₀	-119.51 sec
	Sample 1	PCS Fault ₁	DC Volt ₁	DC Curr ₁	-119.50 sec
	
Trigger Occurred →	Sample 11951	PCS Fault ₁₁₉₅₁	DC Volt ₁₁₉₅₁	DC Curr ₁₁₉₅₁	0.00 sec
Post-Trigger Data →	Sample 11952	PCS Fault ₁₁₉₅₂	DC Volt ₁₁₉₅₂	DC Curr ₁₁₉₅₂	0.01 sec
	
	Sample 15,935	PCS Fault ₁₅₉₃₅	DC Volt ₁₅₉₃₅	DC Curr ₁₅₉₃₅	39.84 sec

With the header information, it is now possible to read as much or as little of the User Log data as desired. Each record in the buffer is read individually by first writing the sample number to **REG 42123 - User Log Get Selected Sample Data**, and then reading the selected data from the corresponding **Data Log Buffer Registers**.

9.2 Fault History Log

The PCS provides two mechanisms for recording the occurrences of the faults defined in **REG 41758 – PCS Fault Status** and **REG 41760 – Factory Fault Status**. The first method uses 16-bit counters (one for each fault bit) to store the total number of occurrences for each fault. The second method stores the date and time of the last six occurrences for each fault. To access the history for either mechanism, a *Fault Index* is used to select each of the possible 64 fault conditions. These indices are assigned to individual fault register bits as shown in the following table:

Table 19 - Fault History Index Assignment

Index	Associated Fault Bit	Fault Condition
0	REG 41758 Bit 0	H/W Over Current A
1	REG 41758 Bit 1	H/W Over Current B
...
31	REG 41758 Bit 31	AC Current Overload Trip
32	REG 41760 Bit 0	H/W DC Over Current A - bot
33	REG 41760 Bit 1	H/W DC Over Current B - bot
...
63	REG 41760 Bit 31	<i>Reserved</i>

9.2.1 Fault Count Log

Each individual fault has an associated 16-bit counter, for a total of 64 counters (32 associated with the fault bits in REG 41758 and 32 associated with the fault bits in REG 41760). These counters increment by +1 for each new occurrence of the corresponding fault condition. The counters will saturate (stop counting) at a maximum count of 65,534 (0xFFFFE).

The user may read a single fault count or multiple counts using **REG 42129 – Operation Log – Read Fault Counts**. This is a 16-bit register in which the LSB is used to specify the fault index of the first count to be read, and the MSB specifies the # of counters to read. After writing to register 42129, the counter can be read from the corresponding **Data Log Buffer Registers**.

For example, to read all 64 counters, write 0x4000 to register 42129 and then read registers 42132 to 42195. The read buffer will be organized as follows:

Read Buffer Address	Counter
42132	Count – REG 41758 Bit 0
42133	Count – REG 41758 Bit 1
...	...
42195	Count – REG 41760 Bit 31

To read a single count, say the H/W Over Current B fault count, write 0x0101 to register 42129 and then read register 42132.

9.2.2 Fault Time Stamp Log

The PCS records the date and time of the last six occurrences for each individual fault condition. The date and time are stored as 32-bit values, formatted according to sections 8.1 and 8.2.

The fault time stamp values can be accessed by first selecting the fault source by writing the fault index to **REG 42124 – Fault History Log Set Fault Index**. **REG 42125 – Fault History Log Number of Entries for Specified Fault** can then be read to determine how many, if any, fault occurrences have been logged (i.e. 0 through 6) for the selected fault condition.

Writing a “1” to **REG 42126 – Fault History Log Get History Data for Specified Fault** will load the fault time stamps into the **Data Log Buffer Registers**. Table 20 illustrates how the time stamp data is arranged within the buffer. Note that the buffer is always loaded with six date and time stamps. The user must read **REG 42125 – Fault History Log Number of Entries for Specified Fault** to determine which, if any, are valid.

Table 20 - Fault Time Stamp Buffer Arrangement

Data Log Buffer Address		Fault Occurrence
42132	MSW	Fault 1 – Date (<i>Oldest</i>)
42133	LSW	
42134	MSW	Fault 1 – Time (<i>Oldest</i>)
42135	LSW	
42136	MSW	Fault 2 – Date
42137	LSW	
42138	MSW	Fault 2 – Time
42139	LSW	
42140	MSW	Fault 3 – Date
42141	LSW	
42142	MSW	Fault 3 – Time
42143	LSW	
42144	MSW	Fault 4 – Date
42145	LSW	
42146	MSW	Fault 4 – Time
42147	LSW	
42148	MSW	Fault 5 – Date
42149	LSW	
42150	MSW	Fault 5 – Time
42151	LSW	
42152	MSW	Fault 6 – Date (<i>Most Recent</i>)
42153	LSW	
42154	MSW	Fault 6 – Time (<i>Most Recent</i>)
42155	LSW	

9.3 Operating History Logs

The operating history log is intended to record critical operating parameters over the life of the PCS. This data includes operating time and min/max values of critical parameters as detailed in the following sections.

9.3.1 Operating Time Log

The PCS keeps track of the cumulative time spent operating under a variety of conditions as defined in Table 21. Each counter is 32-bits wide with each count representing 1 second.

Table 21 - Operating Time Parameter Log

Index	Parameter
0	<i>Factory Data</i>
1	<i>Factory Data</i>
2	Time Powered On
3	Time in Fault State
4	Time in Disabled State
5	Time in Charge Wait State
6	Time in Charging State
7	Time in Standby State
8	Time in Turn-on Delay State
9	Time in Online – Grid Tie State
10	Time in Offline State
11	Time in Active Ride Through State
12	Time in Passive Ride Through State
13	Time in Online – Grid Form State
14	Time in Power Down State
15	Time in Test Mode State
16	Time in Service Disabled State
17	Time Operating: $T_{DC/DC_HS} < 10\text{ }^{\circ}\text{C}$
18	Time Operating: $10 < T_{DC/DC_HS} < 20\text{ }^{\circ}\text{C}$
19	Time Operating: $20 < T_{DC/DC_HS} < 30\text{ }^{\circ}\text{C}$
20	Time Operating: $30 < T_{DC/DC_HS} < 40\text{ }^{\circ}\text{C}$
21	Time Operating: $40 < T_{DC/DC_HS} < 50\text{ }^{\circ}\text{C}$
22	Time Operating: $50 < T_{DC/DC_HS} < 60\text{ }^{\circ}\text{C}$
23	Time Operating: $60 < T_{DC/DC_HS} < 70\text{ }^{\circ}\text{C}$
24	Time Operating: $70 < T_{DC/DC_HS} < 80\text{ }^{\circ}\text{C}$
25	Time Operating: $80 < T_{DC/DC_HS} < 90\text{ }^{\circ}\text{C}$
26	Time Operating: $T_{DC/DC_HS} > 90\text{ }^{\circ}\text{C}$
27	Time Operating: $T_{INV_HS} < 10\text{ }^{\circ}\text{C}$
28	Time Operating: $10 < T_{INV_HS} < 20\text{ }^{\circ}\text{C}$
29	Time Operating: $20 < T_{INV_HS} < 30\text{ }^{\circ}\text{C}$
30	Time Operating: $30 < T_{INV_HS} < 40\text{ }^{\circ}\text{C}$
31	Time Operating: $40 < T_{INV_HS} < 50\text{ }^{\circ}\text{C}$

Index	Parameter
32	Time Operating: $50 < T_{INV_HS} < 60$ °C
33	Time Operating: $60 < T_{INV_HS} < 70$ °C
34	Time Operating: $70 < T_{INV_HS} < 80$ °C
35	Time Operating: $80 < T_{INV_HS} < 90$ °C
36	Time Operating: $T_{INV_HS} > 90$ °C
37	Time Operating: $T_{DC/DC_IGBT} < 10$ °C
38	Time Operating: $10 < T_{DC/DC_IGBT} < 20$ °C
39	Time Operating: $20 < T_{DC/DC_IGBT} < 30$ °C
40	Time Operating: $30 < T_{DC/DC_IGBT} < 40$ °C
41	Time Operating: $40 < T_{DC/DC_IGBT} < 50$ °C
42	Time Operating: $50 < T_{DC/DC_IGBT} < 60$ °C
43	Time Operating: $60 < T_{DC/DC_IGBT} < 70$ °C
44	Time Operating: $70 < T_{DC/DC_IGBT} < 80$ °C
45	Time Operating: $80 < T_{DC/DC_IGBT} < 90$ °C
46	Time Operating: $90 < T_{DC/DC_IGBT} < 100$ °C
47	Time Operating: $100 < T_{DC/DC_IGBT} < 110$ °C
48	Time Operating: $110 < T_{DC/DC_IGBT} < 120$ °C
49	Time Operating: $120 < T_{DC/DC_IGBT} < 130$ °C
50	Time Operating: $130 < T_{DC/DC_IGBT} < 140$ °C
51	Time Operating: $140 < T_{DC/DC_IGBT} < 150$ °C
52	Time Operating: $T_{DC/DC_IGBT} > 150$ °C
53	Time Operating: $T_{INV_IGBT} < 10$ °C
54	Time Operating: $10 < T_{INV_IGBT} < 20$ °C
55	Time Operating: $20 < T_{INV_IGBT} < 30$ °C
56	Time Operating: $30 < T_{INV_IGBT} < 40$ °C
57	Time Operating: $40 < T_{INV_IGBT} < 50$ °C
58	Time Operating: $50 < T_{INV_IGBT} < 60$ °C
59	Time Operating: $60 < T_{INV_IGBT} < 70$ °C
60	Time Operating: $70 < T_{INV_IGBT} < 80$ °C
61	Time Operating: $80 < T_{INV_IGBT} < 90$ °C
62	Time Operating: $90 < T_{INV_IGBT} < 100$ °C
63	Time Operating: $100 < T_{INV_IGBT} < 110$ °C
64	Time Operating: $110 < T_{INV_IGBT} < 120$ °C
65	Time Operating: $120 < T_{INV_IGBT} < 130$ °C
66	Time Operating: $130 < T_{INV_IGBT} < 140$ °C
67	Time Operating: $140 < T_{INV_IGBT} < 150$ °C
68	Time Operating: $T_{INV_IGBT} > 150$ °C
69	Time Operating: $T_{CAB} < 10$ °C
70	Time Operating: $10 < T_{CAB} < 20$ °C
71	Time Operating: $20 < T_{CAB} < 30$ °C
72	Time Operating: $30 < T_{CAB} < 40$ °C
73	Time Operating: $40 < T_{CAB} < 50$ °C
74	Time Operating: $50 < T_{CAB} < 60$ °C
75	Time Operating: $60 < T_{CAB} < 70$ °C
76	Time Operating: $70 < T_{CAB} < 80$ °C

Index	Parameter
77	Time Operating: $80 < T_{CAB} < 90$ °C
78	Time Operating: $T_{CAB} > 90$ °C
79	Time Operating: $V_{DC} < 300$ V
80	Time Operating: $300 < V_{DC} < 350$ V
81	Time Operating: $350 < V_{DC} < 400$ V
82	Time Operating: $400 < V_{DC} < 450$ V
83	Time Operating: $450 < V_{DC} < 500$ V
84	Time Operating: $500 < V_{DC} < 550$ V
85	Time Operating: $550 < V_{DC} < 600$ V
86	Time Operating: $600 < V_{DC} < 650$ V
87	Time Operating: $650 < V_{DC} < 700$ V
88	Time Operating: $700 < V_{DC} < 750$ V
89	Time Operating: $750 < V_{DC} < 800$ V
90	Time Operating: $800 < V_{DC} < 850$ V
91	Time Operating: $V_{DC} > 850$ V
92	Time Operating: $I_{DC} < -80$ A
93	Time Operating: $-80 < I_{DC} < -60$ A
94	Time Operating: $-60 < I_{DC} < -40$ A
95	Time Operating: $-40 < I_{DC} < -20$ A
96	Time Operating: $-20 < I_{DC} < 0$ A
97	Time Operating: $0 < I_{DC} < 20$ A
98	Time Operating: $20 < I_{DC} < 40$ A
99	Time Operating: $40 < I_{DC} < 60$ A
100	Time Operating: $60 < I_{DC} < 80$ A
101	Time Operating: $I_{DC} > 80$ A
102	Time Operating: $V_{AC} < 200$ V _{RMS}
103	Time Operating: $200 < V_{AC} < 250$ V _{RMS}
104	Time Operating: $250 < V_{AC} < 300$ V _{RMS}
105	Time Operating: $300 < V_{AC} < 350$ V _{RMS}
106	Time Operating: $350 < V_{AC} < 400$ V _{RMS}
107	Time Operating: $400 < V_{AC} < 450$ V _{RMS}
108	Time Operating: $450 < V_{AC} < 500$ V _{RMS}
109	Time Operating: $V_{AC} > 500$ V _{RMS}
110	Time Operating: $0 < I_{AC} < 5$ A _{RMS}
111	Time Operating: $5 < I_{AC} < 10$ A _{RMS}
112	Time Operating: $10 < I_{AC} < 15$ A _{RMS}
113	Time Operating: $15 < I_{AC} < 20$ A _{RMS}
114	Time Operating: $20 < I_{AC} < 25$ A _{RMS}
115	Time Operating: $25 < I_{AC} < 30$ A _{RMS}
116	Time Operating: $30 < I_{AC} < 35$ A _{RMS}
117	Time Operating: $35 < I_{AC} < 40$ A _{RMS}
118	Time Operating: $40 < I_{AC} < 45$ A _{RMS}
119	Time Operating: $I_{AC} > 45$ A _{RMS}
120	Time Operating: $P < -35$ kW
121	Time Operating: $-35 < P < -30$ kW

Index	Parameter
122	Time Operating: $-30 < P < -25$ kW
123	Time Operating: $-25 < P < -20$ kW
124	Time Operating: $-20 < P < -15$ kW
125	Time Operating: $-15 < P < -10$ kW
126	Time Operating: $-10 < P < -5$ kW
127	Time Operating: $-5 < P < 0$ kW
128	Time Operating: $0 < P < 5$ kW
129	Time Operating: $5 < P < 10$ kW
130	Time Operating: $10 < P < 15$ kW
131	Time Operating: $15 < P < 20$ kW
132	Time Operating: $20 < P < 25$ kW
133	Time Operating: $25 < P < 30$ kW
134	Time Operating: $30 < P < 35$ kW
135	Time Operating: $P > 35$ kW
136	Time Operating: $I_{AC} < 25 A_{RMS}$ and $T_{CAB} < 30$ °C
137	Time Operating: $I_{AC} < 25 A_{RMS}$ and $30 < T_{CAB} < 40$ °C
138	Time Operating: $I_{AC} < 25 A_{RMS}$ and $40 < T_{CAB} < 50$ °C
139	Time Operating: $I_{AC} < 25 A_{RMS}$ and $50 < T_{CAB} < 60$ °C
140	Time Operating: $I_{AC} < 25 A_{RMS}$ and $T_{CAB} > 60$ °C
141	Time Operating: $I_{AC} > 25 A_{RMS}$ and $T_{CAB} < 30$ °C
142	Time Operating: $I_{AC} > 25 A_{RMS}$ and $30 < T_{CAB} < 40$ °C
143	Time Operating: $I_{AC} > 25 A_{RMS}$ and $40 < T_{CAB} < 50$ °C
144	Time Operating: $I_{AC} > 25 A_{RMS}$ and $50 < T_{CAB} < 60$ °C
145	Time Operating: $I_{AC} > 25 A_{RMS}$ and $T_{CAB} > 60$ °C
146-156	<i>Reserved</i>
157	Fan Operating Time
158	<i>Reserved</i>

The user may read a single operating time value or up to a maximum of 35 (i.e. full length of **Data Log Buffer**) by using **REG 42128 – Operation Log Read Timer Variables**. This is a 16-bit register in which the LSB is used to specify the index of the first value to be read, and the MSB specifies the number of values to read. After writing to register 42128, the times can be read from the corresponding **Data Log Buffer Registers**.

For example, to read “Time Operating: $P > 35$ kW”, write 0x0187 to register 42128 and then read registers 42132 and 42133 for the 32-bit time in secs, where 42132 holds the MSW and 42133 the LSW.

To read the three consecutive times: “Time Powered on”, “Time in Fault State”, “Time in Disabled State”, write 0x0302 to register 42128 and then read registers 42132 to 42137. The read buffer will be organized as follows:

Data Log Buffer Address		Operating Time
42132	MSW	Time Powered On
42133	LSW	
42134	MSW	Time in Fault State
42135	LSW	
42136	MSW	Time in Disabled State
42137	LSW	

9.3.2 Min/Max Log

The PCS keeps track of minimum and maximum values for the parameters listed in Table 22.

Table 22 - Min/Max Parameter Log

Parameter Index	Parameters	Units	Data Type
0	Max – AC Voltage Phase AB	0.1 V _{RMS}	U16
1	Max – AC Voltage Phase BC	0.1 V _{RMS}	U16
2	Max – AC Voltage Phase CA	0.1 V _{RMS}	U16
3	Max – AC Voltage Phase A	0.1 V _{RMS}	U16
4	Max – AC Voltage Phase B	0.1 V _{RMS}	U16
5	Max – AC Voltage Phase C	0.1 V _{RMS}	U16
6	Max – AC Current Phase A	0.1 A _{RMS}	U16
7	Max – AC Current Phase B	0.1 A _{RMS}	U16
8	Max – AC Current Phase C	0.1 A _{RMS}	U16
9	Max – Inverter Current Phase A	0.1 A _{RMS}	U16
10	Max – Inverter Current Phase B	0.1 A _{RMS}	U16
11	Max – Inverter Current Phase C	0.1 A _{RMS}	U16
12	Max – Active AC Power (P)	10 W	S16
13	Max – Reactive AC Power (Q)	10 VAR	S16
14	Max – AC Frequency	0.001 Hz	U32
15	Max – DC Link Voltage	0.1 V	U16
16	Max – DC Link Top	0.1 V	U16
17	Max – DC Link Bottom	0.1 V	U16
18	Max – DC Voltage	0.1V	U16
19	Max – DC Current	0.1 A	S16
20	Max – DC Current Phase A High Side	0.1 A	S16
21	Max – DC Current Phase B High Side	0.1 A	S16
22	Max – DC Current Phase C High Side	0.1 A	S16
23	Max – DC Current Phase A Low Side	0.1 A	S16
24	Max – DC Current Phase B Low Side	0.1 A	S16
25	Max – DC Current Phase C Low Side	0.1 A	S16
26	Max – 24V Bias	0.01 V	U16
27	Max – Heatsink Temp DC/DC Phase A	°C	S16
28	Max – Heatsink Temp DC/DC Phase B	°C	S16
29	Max – Heatsink Temp DC/DC Phase C	°C	S16
30	Max – Heatsink Temp Inverter Phase A	°C	S16

Parameter Index	Parameters	Units	Data Type
31	Max – Heatsink Temp Inverter Phase B	°C	S16
32	Max – Heatsink Temp Inverter Phase C	°C	S16
33	Max – Estimated IGBT Temp DC/DC	°C	S16
34	Max – Estimated IGBT Temp Inverter	°C	S16
35	Max – Cabinet Temperature	°C	S16
36	Max – Ambient Temperature (<i>not supported</i>)	°C	S16
37	Min – Active AC Power (P)	10 W	S16
38	Min – Reactive AC Power (Q)	10 VAR	S16
39	Min – AC Frequency	0.001 Hz	U32
40	Min – DC Current	0.1 A	S16
41	Min – DC Current Phase A High Side	0.1 A	S16
42	Min – DC Current Phase B High Side	0.1 A	S16
43	Min – DC Current Phase C High Side	0.1 A	S16
44	Min – DC Current Phase A Low Side	0.1 A	S16
45	Min – DC Current Phase B Low Side	0.1 A	S16
46	Min – DC Current Phase C Low Side	0.1 A	S16
47	Min – Heatsink Temp DC/DC Phase A	°C	S16
48	Min – Heatsink Temp DC/DC Phase B	°C	S16
49	Min – Heatsink Temp DC/DC Phase C	°C	S16
50	Min – Heatsink Temp Inverter Phase A	°C	S16
51	Min – Heatsink Temp Inverter Phase B	°C	S16
52	Min – Heatsink Temp Inverter Phase C	°C	S16
53	Min – Estimated IGBT Temp DC/DC	°C	S16
54	Min – Estimated IGBT Temp Inverter	°C	S16
55	Min – Cabinet Temperature	°C	S16
56	Min – Ambient Temperature (<i>not supported</i>)	°C	S16

The user may read a single parameter or multiple parameters by using **REG 42130 – Operation Log Read Min/Max Values**. This is a 16-bit register in which the LSB is used to specify the index of the first parameter to be read, and the MSB specifies the # of parameters to read. After writing to register 42130, the parameters can be read from the corresponding **Data Log Buffer Registers**.

For example, to read “Min – Cabinet Temperature”, write 0x0137 to register 42130 and then read register 42132.

To read the four consecutive parameters: “Min – Active Power (P)”, “Min – Reactive Power (Q)”, “Min – AC Frequency”, “Min – DC Current”, write 0x0425 to register 42130 and then read registers 42132 to 42136. The read buffer will be organized as shown below (note that 32-bit values are returned LSW first followed by MSW):

Data Log Buffer Address	Parameter
42132	Min – AC Active Power (P)
42133	Min – AC Reactive Power (Q)
42134	Min – AC Frequency (LSW)
42135	Min – AC Frequency (MSW)
42136	Min – DC Current

10. Communications Interface

The PCS is equipped with a Modbus RS485 communications interface. Modbus is an application layer messaging protocol that provides client/server communication between devices connected on different types of buses or networks.

Table 23 - Modbus Interface Specifications

Interface	RS-485
Data Transfer Method	Half duplex
Data Transfer Speed	User Configurable
Protocol	Modbus RTU over Serial Interface
Connector	D-Sub 15
Cable Type	Twisted Pair
Default Slave Address	1, User Configurable
Response Time	Time from receipt of message to beginning of reply: <ul style="list-style-type: none"> • 2.5ms max - Command/Instrumentation Registers • 8ms max - Configuration Registers

10.1 Modbus Overview

Modbus is a request/reply protocol and offers services specified by *function codes*, which are elements of Modbus request/reply protocol data units (PDUs). The MODBUS application protocol specifies that all requests are initiated by a client. The function code field indicates to the server what kind of action to perform and is coded in one byte. Valid codes are in the range of 1 ... 255 decimal (the range 128 – 255 is reserved and used for exception responses). When a message is sent from a Client to a Server device the function code field tells the server what kind of action to perform. Function code "0" is not valid. Sub-function codes are added to some function codes to define multiple actions. The data field of messages sent from a client to server devices contains additional information that the server uses to take the action defined by the function code. This can include items like discrete and register addresses, the quantity of items to be handled, and the count of actual data bytes in the field. The data field may be nonexistent (of zero length) in certain kinds of requests, in this case the server does not require any additional information. The function code alone specifies the action.

If no error occurs related to the Modbus function requested in a properly received Modbus ADU, the data field of a response from a server to a client contains the data requested. If an

error related to the Modbus function requested occurs, the field contains an exception code that the server application can use to determine the next action to be taken. For example, a client can read the ON / OFF states of a group of discrete outputs or inputs or it can read/write the data contents of a group of registers. When the server responds to the client, it uses the function code field to indicate either a normal (error-free) response or that an error occurred (called an exception response). For a normal response, the server simply echoes to the request the original function code.

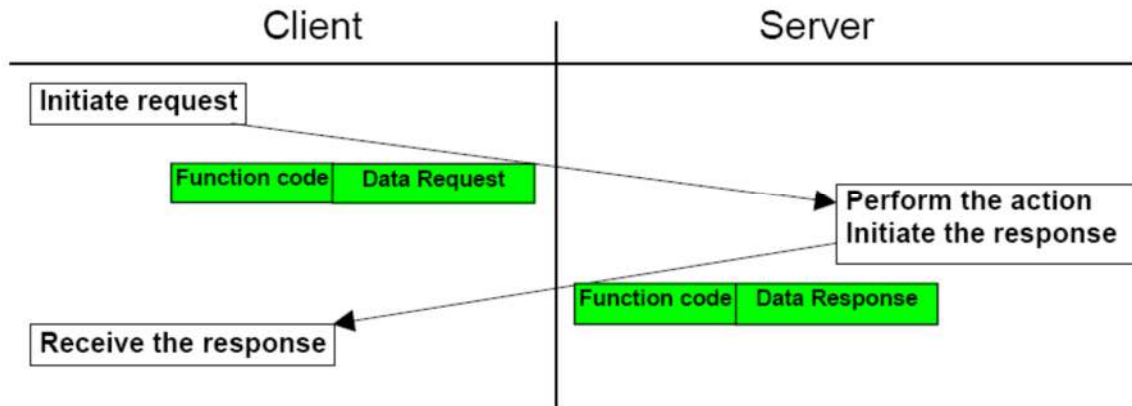

For an exception response, the server returns a code that is equivalent function code from the request PDU with its most significant bit set to logic 1.

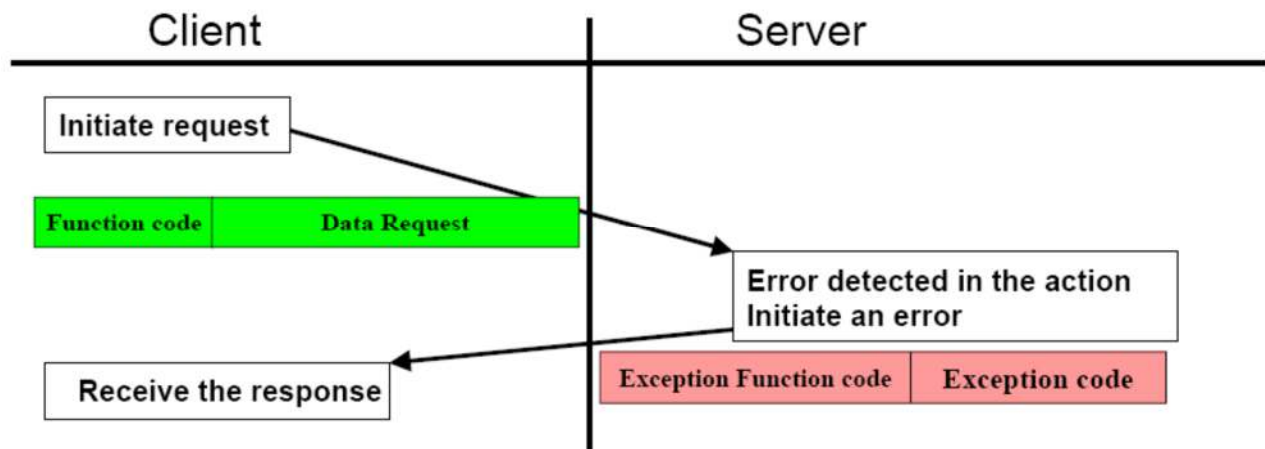

10.2 Physical Layer

The RS-485 physical interface conforms to the Modbus specification published on the Modbus.org site in 2002 (Modbus_over_serial_line_V1.pdf, Nov 2002).

10.3 RTU Transmission Mode

Modbus supports two modes of transmission, ASCII (American Standard Code for Information Interchange), and RTU (Remote Terminal Unit). The PCS uses the more efficient RTU transmission mode. The Modbus specification defines the message frame or Serial Line PDU “Protocol Data Unit” as shown in Figure 32.

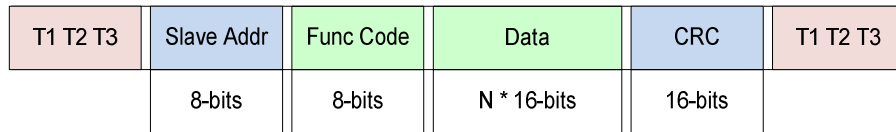

Figure 32 - RTU Message Frame (PDU) Format

10.3.1 Synchronization

The Modbus specification for synchronization is as follows: Frame synchronization is established by limiting the elapsed time between receipt of characters. The T1, T2, T3 items at the beginning and end of the frame depict approximately three character times of idle time. If three character times elapse without a new character or completion of a frame, then the pending message will be flushed, and the next byte received will be treated as the address field of the message frame.

10.3.2 Slave Address

The 8-bit slave address field defines the unique ID (1-247) of the slave device that is to receive the message sent by the master. When the slave sends a response, the slave address field informs the master which slave is communicating.

The PCS supports Slave Address 0, which is used for Modbus *Broadcast Mode*. In *Broadcast Mode*, the Modbus Master can send a message to **all** slaves on the network at the same time. In this mode, slaves do not reply to the Modbus Master. Using *Broadcast Mode* is useful when operating multiple PCS units in parallel and the user wants them all to respond to the same register commands simultaneously, such as when turning on or off or changing operating setpoints.

10.3.3 Function Code

The 8-bit function code tells the addressed slave what function to perform. If the slave is able to perform the requested function, the function code in the response will be that of the request. The slave will set the high order bit of the function code to one in the response to indicate an exception.

10.3.4 Data Field

The data field will vary in length according to which function is specified. This field contains information required by the slave to perform the specific function or it contains data collected by the slave in response to a query.

Modbus uses a 'Big-Endian' representation for addresses and data items. This means that when a numerical quantity larger than a single byte is transmitted, the most significant byte is sent first. For example, a 16-bit register size value of 0x1234 would be transmitted with the first byte sent being 0x12 then 0x34.

10.3.5 CRC Error Check

The two-byte error check field allows the master and slave devices to check messages for transmission errors. A Cyclic Redundancy Check (CRC) is performed by the master and the slave devices. The error checking assures that the master or slave does not react to messages that have changed during transmission.

The CRC-16 polynomial is used to compute the checksum for the message content. The formula for the CRC-16 polynomial is:

$$x^{16} + x^{15} + x^2 + 1$$

The checksum can be computed using the following algorithm:

1. Load a 16-bit register with all 1's.
2. Exclusive OR the first 8-bit byte of the message with the high order byte of the 16-bit register, putting the result in the 16-bit register.
3. Shift the 16-bit register 1 bit to the right.
4. If the bit shifted out to the right is a 1, exclusive OR the generating polynomial (1010 0000 0000 0001) with the 16-bit register. If the bit is a 0, do not modify the register.
5. Repeat steps 3 & 4 until 8 shifts have been performed.
6. Exclusive OR the next 8-bit byte of the message with the 16-bit register.
7. Repeat steps 3 through 6 until all bytes of the message have been exclusive OR'd with the 16-bit register and shifted eight times.
8. The final content of the register is the CRC value

When the 16-bit CRC value is transmitted in the message, the low-order byte must be transmitted first, followed by the high-order byte.

10.3.6 Exception Response

There are two possible exception modes the PCS must handle:

- The PCS (slave) receives the request, but detects a communication error (parity, LRC, CRC, ...), no response is returned. The host will eventually process a timeout condition for the request.
- The PCS (slave) receives the request without a communication error, but cannot handle it (for example, if the request is to read a non-existent output or register), the PCS will return an exception response informing the host of the nature of the error.

When the PCS detects an error, it sends a response message to the host consisting of the function code (with high order bit set to one) and an error code (8-bits). The exception error codes are as follows:

Table 24 - Modbus Exception Codes

Code	Name	Meaning
01	Illegal Function	The message function is not supported by the PCS.
02	Illegal Data Address	The address (in the write request) or start address (in the read request) referenced in the data field is not valid.
03	Illegal Data Value	The value or count specified in the data field is not allowable.

10.4 Function Code Descriptions

The PCS provides a subset of the available Modbus functions, namely functions 3 (Read Holding Registers), 6 (Preset Single Register), and 16 (Write Multiple Registers).

10.4.1 Read Holding Registers (Function Code 03)

This function code is used to read the contents of a contiguous block of registers. The request PDU specifies the starting register address and the number of registers. In the PDU registers are addressed starting at zero. Therefore, registers numbered 1-16 are addressed as 0-15.

The response includes the slave address, function code, length of response values in bytes, the response values, and error check. The data consists of two bytes for each register, with the binary content right justified within each pair. The first byte includes the high order bits and the second, the low order bits.

Request PDU:

Slave Addr	Func Code	Starting Address	# of Registers	CRC
8-bits	8-bits	16-bits	16-bits	16-bits

Response PDU:

Slave Addr	Func Code	Data Length	Data ... Data		CRC
8-bits	8-bits	8-bits	16-bits	16-bits	16-bits

Error PDU:

Slave Addr	Error Code	Exception Code	CRC
8-bits	0x83	8-bits	16-bits

Here is an example request to read **REG 40130-40132 – AC Current A, AC Voltage AB, AC Voltage AN**, from slave 10:

Request		Response	
Field Name	(Hex)	Field Name	(Hex)
Slave Address	0A	Slave Address	0A
Function	03	Function	03
Starting Address Hi	9C	Byte Count	06
Starting Address Lo	C1	Reg Value Hi (40130)	01
# of Registers Hi	00	Reg Value Lo (40130)	2C
# of Registers Lo	03	Reg Value Hi (40131)	12
CRC Hi	crc_h	Reg Value Lo (40131)	C0
CRC Lo	crc_l	Reg Value Hi (40132)	0A
		Reg Value Lo (40132)	D3
		CRC Hi	crc_h
		CRC Lo	crc_l

10.4.2 Preset Single Command Register (Function Code 06)

This function code is used to write a single holding register. The request PDU specifies the address of the register to be written. Registers are addressed starting at zero. Therefore, register numbered 1 is addressed as 0. The normal response is an echo of the request, returned after the register contents have been written.

Request PDU:

Slave Addr	Func Code	Register Address	Register Value	CRC
8-bits	8-bits	16-bits	16-bits	16-bits

Response PDU:

Slave Addr	Func Code	Register Address	Register Value	CRC
8-bits	8-bits	16-bits	16-bits	16-bits

Error PDU:

Slave Addr	Error Code	Exception Code	CRC
8-bits	0x86	8-bits	16-bits

Here is an example request to write **REG 40339 – Set Active Power Percent Setpoint** with a value of 12.5% on Slave 10:

Request		Response	
Field Name	(Hex)	Field Name	(Hex)
Slave Address	0A	Slave Address	0A
Function	06	Function	06
Register Address Hi	9D	Register Address Hi	9D
Register Address Lo	92	Register Address Lo	92
Register Value Hi	00	Register Value Hi	00
Register Value Lo	7D	Register Value Lo	7D
CRC Hi	crc_h	CRC Hi	crc_h
CRC Lo	crc_l	CRC Lo	crc_l

10.4.3 Write Multiple Registers (Function Code 16)

This function code is used to write a block of contiguous registers (1 to 123 registers). The requested written values are specified in the request data field. Data is packed as two bytes per register. The normal response returns the function code, starting address, and quantity of registers written.

Request PDU:

Slave Addr	Func Code	Starting Address	# of Registers	Byte Count	Register Values	CRC
8-bits	8-bits	16-bits	16-bits	8-bits	16-bits x n	16-bits

n = # of registers

Response PDU:

Slave Addr	Func Code	Starting Address	# of Registers	CRC
8-bits	8-bits	16-bits	16-bits	16-bits

Error PDU:

Slave Addr	Error Code	Exception Code	CRC
8-bits	0x90	8-bits	16-bits

Here is an example request to write 2 registers on Slave 10, **REG 40433/40434 – Volt-VAR Curve 2: Point 1 – Volts/VARs**, to values of 92.00% and 44.00%:

Request		Response	
Field Name	(Hex)	Field Name	(Hex)
Slave Address	0A	Slave Address	0A
Function	10	Function	10
Starting Address Hi	9D	Starting Address Hi	9D
Starting Address Lo	F0	Starting Address Lo	F0
# of Registers Hi	00	# of Registers Hi	00
# of Registers Lo	02	# of Registers Lo	02
Byte Count	04	CRC Hi	crc_h
Register Value Hi (40433)	23	CRC Lo	crc_l
Register Value Lo (40433)	F0		
Register Value Hi (40434)	11		
Register value Lo (40434)	30		
CRC Hi	crc_h		
CRC Lo	crc_l		

11. SunSpec Device Information Models

SunSpec Device Information Models are used to provide a simple method for communicating with the PCS. These models provide a standardized collection of registers to achieve plug-and-play interoperability between Distributed Energy Resource (DER) components and smart grid applications. In particular, the PCS takes advantage of the 700-series information models that support all DER interoperability functionality specified in IEEE 1547-2018. Additionally, Oztek’s vendor-specific information models are used for any status, control, and configuration of the PCS that falls outside of the standard SunSpec models. For further details on SunSpec specifications and information models, visit the SunSpec Alliance web site at sunspec.org/specifications.

The table below lists the standard SunSpec information models as well as the Oztek-specific models implemented in the PCS. Each of these models is then described in more detail in the sections that follow.

Table 25 - SunSpec Models

Model ID	Description
1	Common Model
17	Serial Interface
701	DER AC Measurement
702	DER Capacity
703	Enter Service
704	DER AC Controls
705	DER Volt-VAR
706	DER Volt-Watt
707	DER Low Voltage Trip (LVRT)
708	DER High Voltage Trip (HVRT)
709	DER Low Frequency Trip (LFRT)
710	DER High Frequency Trip (HFRT)
711	DER Frequency Droop (Freq-Watt)
712	DER Watt-VAR
714	DER DC Measurement
715	DER Control
64340	Oztek PCS - Control and Status
64341	Oztek PCS - Configuration
64302	Oztek PCS - Alarms
64304	Oztek PCS - Firmware Update
64305	Oztek PCS - Datalogging
64308	Oztek PCS - Grid Forming Configuration & Control
0xFFFF	End Model

11.1 Register Properties

11.1.1 Register Number

The register *Number* listed in the tables below represents the Modbus identifier for each parameter. It is important to note that these register *numbers* are 1-based, meaning they start counting from 1. This differs from the physical *address* that is transmitted across the bus when accessing these registers. The physical *addresses* are 0-based, meaning they start counting from 0.

Notice: *Offset of Modbus Register Numbers*

To read or write Modbus registers the “Address” is 1 less than the register number. Example: Address of Register 40001 is $40001 - 1 = 40000$.

11.1.2 Access Level

The access level for each register is defined as follows:

W = Writeable – the parameter is writable by the user

R = Readable – the parameter is readable by the user

O = Operating – the parameter may *NOT* be written while the PCS is ON, writes to any parameter with this indicator will be ignored if the PCS is ON

11.1.3 SunSpec Data Formats

- **int**: signed integer value.
- **uint**: unsigned integer value
- **pad**: reserved field, used to round a Model to an even number of registers
- **acc**: accumulated value, used for ever increasing values that may rollover
- **enum**: enumerated value, used for status and state
- **bitfield**: a collection of bits, multi-valued alarms or state
- **string**: a null terminated or fixed length value
- **sunssf**: defines value to shift decimal point to left (negative) or right (positive)

11.1.4 SunSpec Data Type U16

U16 represents all unsigned, 16-bit integer values and consist of a single register. Values are stored in big-endian order.

Modbus Register	1															
Byte	0								1							
Bits	15	14	13	12	10	11	9	8	7	6	5	4	3	2	1	0

U16 Format	Range	Not Implemented Value
Integer	0 ... 65534	0xFFFF
Acc16	0 ... 65534	0x0000
ENUM	0 65534	0xFFFF
Bitfield	0 0x7FFF	0xFFFF
Pad	0x8000	Always returns 0x8000

11.1.5 SunSpec Data Type S16

S16 represents all signed, 16-bit integer values and consist of a single register. Values are stored in big-endian order.

Modbus Register	1															
Byte	0								1							
Bits	15	14	13	12	10	11	9	8	7	6	5	4	3	2	1	0

S16 Format	Range	Not Implemented Value
Integer	-32767 ... 32767	0x8000
Sunssf	-10 ... 10	0x8000

11.1.6 SunSpec Data Type U32

U32 represents all unsigned, 32-bit integer values and consist of two registers in big-endian order.

Modbus Register	1		2	
Byte	0	1	2	3
Bits	31 ... 24	23 ... 16	15 ... 8	7 ... 0

U32 Format	Range	Not Implemented Value
Integer	0 ... 4,292,967,294	0xFFFF FFFF
Acc32	1 ... 4,292,967,295	0x0000 0000
ENUM	0 ... 4,292,967,294	0xFFFF FFFF
Bitfield	0 ... 0x7FFF FFFF	0xFFFF FFFF

11.1.7 SunSpec Data Type S32

S32 represents all unsigned, 32-bit integer values and consist of two registers in big-endian order.

Modbus Register	1		2	
Byte	0	1	2	3
Bits	31 ... 24	23 ... 16	15 ... 8	7 ... 0

S32 Format	Range	Not Implemented Value
Integer	-2,147,483,647 2,147,483,647	0x8000 0000

11.1.8 SunSpec Data Type U64

U64 represents all unsigned, 64-bit integer values and consist of four registers in big-endian order.

Modbus Register	1		2	
Byte	0	1	2	3
Bits	63 ... 56	55 ... 48	47 ... 40	39 ... 32

Modbus Register	3		4	
Byte	4	5	6	7
Bits	31 ... 24	23 ... 16	15 ... 8	7 ... 0

U32 Format	Range	Not Implemented Value
Integer	0 ... 9,223,372,036,854,775,806	0xFFFF FFFF FFFF FFFF
Acc32	1 ... 9,223,372,036,854,775,807	0x0000 0000 0000 0000
ENUM	0 ... 9,223,372,036,854,775,806	0xFFFF FFFF FFFF FFFF
Bitfield	0 0x7FFF FFFF FFFF FFFF	0xFFFF FFFF FFFF FFFF

11.1.9 SunSpec Data Type String

String represents a variable length string value in a fixed size register range using a NULL (0 value) to terminate or pad the string. For example, up to 16 characters can be stored in 8 contiguous registers as follows:

Modbus Register	1		2		3		4		5		6		7		8	
Byte	0	1	2	3	4	5	6	7	8	9	10	11	12	13	14	15
Character	E	X	A	M	P	L	E	spc	S	T	R	I	N	G	!	NULL

Not Implemented Value: all registers filled with NULL or 0x0000.

11.2 SunSpec Curve-Based Register Models

Several SunSpec information models implement control functions using piece-wise linear curves to specify the behavior for that function. For these models, curves are defined using a set of management points. These curve-based register models follow a common set of rules for specifying, storing, and updating these management points. The table below lists the specific register models that utilize this curve management methodology.

Table 26 - SunSpec Curve-Based Models

Model ID	Description
705	DER Volt-VAR
706	DER Volt-Watt
707	DER Low Voltage Trip (LVRT)
708	DER High Voltage Trip (HVRT)
709	DER Low Frequency Trip (LFRT)
710	DER High Frequency Trip (HFRT)
711	DER Frequency Droop (Freq-Watt)
712	DER Watt-VAR

Note that Model 711 – DER Frequency Droop is included in the list above. Unlike the other models shown whose curves are literally defined by a series of curve points, the Frequency Droop controller is slightly different in that its curve is mathematically derived from a set of parameters including a desired slope and inflection points. For this reason, the register sets defining the Frequency Droop behavior are described as “controllers” instead of “curves”, but the same curve management process described in this section still applies to this model.

11.2.1 Curve Sets

The SunSpec curve methodology generically allows for the creation of multiple curve sets. For all curve-based models implemented by the PCS, two curves are used.

The first curve (Curve 1) represents the “active” curve that is presently being used by the PCS. This curve is read-only and cannot be modified by the user. The settings in this curve are backed up in non-volatile memory such that the functional behavior is retained between power cycles.

The second curve (Curve 2) is considered a “scratch area” for editing the curve settings and defining a new behavior to be loaded into Curve 1 when complete. The registers in this curve are writable by the user and are volatile, meaning their values are not retained between power cycles. Instead, at POR the Curve 2 registers are loaded with the stored Curve 1 values so that the “scratch area” is initialized to the last “active” curve settings.

11.2.2 Adopting a New Curve

Each of the curve-based models listed in the table above contain a dedicated **Module Enable** register. This register is used enable or disable the functionality controlled by that register model. As mentioned above, when a module is enabled, the module uses the functionality defined in the Curve 1 registers – i.e. the “active” curve.

In order to change the behavior for a given function, a new set of values must be loaded into the Curve 1 registers. This is done by first writing the new desired settings to the “scratch area” in Curve 2. Once all the settings have been adjusted as desired, the user must write to the dedicated **Adopt Curve Request** register for that module. The value written to this register is

the curve number with the settings that the user wishes to adopt. Because the PCS only supports two curves, and Curve 1 is the read-only “active” curve, the user would write the number **2** to the request register to indicate that they want to load the settings from Curve 2 into the active curve in Curve 1.

Once a request to adopt the new Curve 2 settings has been issued, the PCS will first verify if the new settings follow the function-specific curve rules defined in earlier sections of this document. If the new curve settings are valid, then will then be loaded into Curve 1 and the PCS will start enforcing the newly adopted curve behavior. The PCS will also then kick off the process of copying these settings to non-volatile memory so that they can be retained between power cycles. The time to complete this curve backup varies depending on the register model and the number of registers in the curve, typically ranging from roughly 30ms to 250ms.

After writing to the **Adopt Curve Request** register, the user can read from the module’s **Adopt Curve Result** register to see the status of the request as follows:

- **IN PROGRESS** – this status is returned just after a new request has been issued and while the PCS is still verifying the curve settings or waiting for the curve backup to finish.
- **COMPLETED** – this status indicates that the new curve settings were valid, backed up successfully, and are now being used as the “active” curve in Curve 1.
- **FAILED** – this status indicates that the Curve 2 settings were not valid and therefore the “active” curve settings in Curve 1 *were not changed*. To determine why the curve settings failed, see the sections earlier in this document that describe the curve rules for the corresponding function.

In general, the active curve settings in Curve 1 should always be valid as the PCS ships from the factory with valid default curves and any changes to the active curve are first validated by the adoption process described above. However, it is possible for the Curve 1 settings to become corrupted in a way that would create an invalid curve. This can happen if the user issues an adopt curve request and then removes power from the PCS before it has had time to finish backing up the curve in non-volatile memory. To protect against operating with invalid curve settings, at POR the PCS reads and verifies the Curve 1 settings against the specified rules. If an invalid curve is detected that module’s **Adopt Curve Result** register will be initialized to **FAILED** and the module’s **Enable** register will be forced to **DISABLED**. Additionally, an **Invalid User Configuration** fault will be asserted, and the offending module will be reported in **REG 41762 – User Configuration Error Status**. To correct this, the user must load Curve 2 with the desired valid settings and repeat the adoption process described above.

11.3 Register Models

The following sections tabulate the registers for each of the SunSpec and Oztek models implemented in the PCS. The tables only include the implemented registers, Modbus reads of unimplemented SunSpec registers will return the “Not Implemented” values defined in sections 11.1.4 through 11.1.9.

11.3.3 SunSpec Model 17 Registers – Serial Interface

Number	Data Type	Description	Units	Scale Factor (Reg #)	Factory Default	Min	Max	Access Level
Header:								
40071	U16	Model Identifier	n/a	n/a	17	n/a	n/a	R
40072	U16	Model Length - # of 16-bit registers to follow	n/a	n/a	12	n/a	n/a	R
Fixed Block:								
40077	U32	Baud Rate: Supported values = 4800, 19200, 38400, 57600, and 115200 (all others result in default of 57600)	bps	n/a	57600	4800	115200	RWO ¹
40079	U16	Bits Per Character: 8 (only 8-bit transfers are not supported)	n/a	n/a	8	8	8	RW
40080	U16	Parity: 0 = None; 1 = Odd; 2 = Even	ENUM	n/a	0	0	2	RWO ¹
40081	U16	Duplex: 1 = Half (full duplex is not supported)	ENUM	n/a	1	1	1	RW
40082	U16	Flow Control: 0 = None (flow control is not supported)	ENUM	n/a	0	0	0	RW
40083	U16	Interface type: 2 = RS485	ENUM	n/a	2	n/a	n/a	R
40084	U16	Protocol: 1 = Modbus	ENUM	n/a	1	n/a	n/a	R

¹ New value will not take effect until next POR

² The number of **STOP BITS** (not included in model) is fixed at '1'

11.3.4 SunSpec Model 701 Registers – DER AC Measurement

Number	Data Type	Description	Units ¹	Scale Factor (Reg #)	Factory Default	Min	Max	Access Level
Header:								
40085	U16	Model Identifier	n/a	n/a	701	n/a	n/a	R
40086	U16	Model Length - # of 16-bit registers to follow	n/a	n/a	153	n/a	n/a	R
Fixed Block:								
40087	U16	AC Wiring Type: 0 = Single Phase; 1 = Split Phase; 2 = Three Phase	ENUM	n/a	2	n/a	n/a	R
40088	U16	Operating State: 0 = Off; 1 = On	ENUM	n/a	n/a	n/a	n/a	R
40090	U16	Grid Connection State: 0 = Disconnected; 1 = Connected	ENUM	n/a	n/a	n/a	n/a	R

Number	Data Type	Description	Units ¹	Scale Factor (Reg #)	Factory Default	Min	Max	Access Level
40091	U32	DER Alarm Bitfield: Bit 1 = DC Over Voltage Bit 2 = AC Disconnect Bit 3 = DC Disconnect Bit 4 = Grid Disconnect Bit 7 = Over Temperature Bit 8 = Over Frequency Bit 9 = Under Frequency Bit 10 = AC Over Voltage Bit 11 = AC Under Voltage Bit 13 = Under Temperature Bit 14 = Memory Loss Bit 16 = Manufacturer Alarm All Others = <i>Not supported</i>	Bitfield	n/a	n/a	n/a	n/a	R
40093	U32	DER Mode Bitfield: Bit 0 = Grid Following Bit 1 = Grid Forming All Others = <i>Not supported</i>	Bitfield	n/a	n/a	n/a	n/a	R
40095	S16	Active Power ²	10 W	40201	n/a	n/a	n/a	R
40096	S16	Apparent Power	10 VA	40203	n/a	n/a	n/a	R
40097	S16	Reactive Power ³	10 VAR	40204	n/a	n/a	n/a	R
40098	S16	Power Factor ⁴	n/a	40202	n/a	n/a	n/a	R
40099	S16	AC Current (sum of all phases)	0.1 Arms	40198	n/a	n/a	n/a	R
40100	U16	Average AC Line-to-Line Voltage	0.1 Vrms	40199	n/a	n/a	n/a	R
40101	U16	Average AC Line-to-Neutral Voltage	0.1 Vrms	40199	n/a	n/a	n/a	R
40102	U32	Line Frequency	0.001 Hz	40200	n/a	n/a	n/a	R
40120	S16	Temperature - Ambient (<i>not supported, always returns 0</i>)	C	40207	n/a	n/a	n/a	R
40121	S16	Temperature - Cabinet	C	40207	n/a	n/a	n/a	R
40122	S16	Temperature - Inverter Heat Sink	C	40207	n/a	n/a	n/a	R
40124	S16	Temperature - Max Estimated IGBT Temp	C	40207	n/a	n/a	n/a	R
40130	S16	AC Current - Phase A	0.1 Arms	40198	n/a	n/a	n/a	R
40131	U16	AC Voltage - AB	0.1 Vrms	40199	n/a	n/a	n/a	R
40132	U16	AC Voltage - AN	0.1 Vrms	40199	n/a	n/a	n/a	R
40153	U16	AC Current - Phase B	0.1 Arms	40198	n/a	n/a	n/a	R
40154	S16	AC Voltage - BC	0.1 Vrms	40199	n/a	n/a	n/a	R
40155	S16	AC Voltage - BN	0.1 Vrms	40199	n/a	n/a	n/a	R
40176	U16	AC Current - Phase C	0.1 Arms	40198	n/a	n/a	n/a	R
40177	S16	AC Voltage - CA	0.1 Vrms	40199	n/a	n/a	n/a	R
40178	S16	AC Voltage - CN	0.1 Vrms	40199	n/a	n/a	n/a	R
40198	S16	Scale Factor - AC Current	sunssf	n/a	-1	n/a	n/a	R

Number	Data Type	Description	Units ¹	Scale Factor (Reg #)	Factory Default	Min	Max	Access Level
40199	S16	Scale Factor - AC Voltage	sunssf	n/a	-1	n/a	n/a	R
40200	S16	Scale Factor - Line Frequency	sunssf	n/a	-3	n/a	n/a	R
40201	S16	Scale Factor - AC Power	sunssf	n/a	1	n/a	n/a	R
40202	S16	Scale Factor - Power Factor	sunssf	n/a	-3	n/a	n/a	R
40203	S16	Scale Factor - AC Apparent Power	sunssf	n/a	1	n/a	n/a	R
40204	S16	Scale Factor - AC Reactive Power	sunssf	n/a	1	n/a	n/a	R
40207	S16	Scale Factor - Temperature	sunssf	n/a	0	n/a	n/a	R

¹ Units include applied scale factor register

² Positive value indicates active power delivered to the grid

³ Positive value indicates reactive power delivered to the grid (over-excited, phase current lags phase voltage)

⁴ Power Factor sign follows the sign of the active power (positive indicates active power delivered to the grid)

11.3.5 SunSpec Model 702 Registers – DER Capacity

Number	Data Type	Description	Units ¹	Scale Factor (Reg #)	Factory Default	Min	Max	Access Level
Header:								
40240	U16	Model Identifier	n/a	n/a	702	n/a	n/a	R
40241	U16	Model Length - # of 16-bit registers to follow	n/a	n/a	50	n/a	n/a	R
Fixed Block:								
40242	U16	Active Power Max Rating at Unity Power Factor	10 W	40285	4000	n/a	n/a	R
40243	U16	Active Power Max Rating at Specified Over-Excited Power Factor	10 W	40285	3592	n/a	n/a	R
40244	U16	Specified Over-Excited Power Factor	0.001	40286	898	n/a	n/a	R
40245	U16	Active Power Max Rating at Specified Under-Excited Power Factor	10 W	40285	3592	n/a	n/a	R
40246	U16	Specified Under-Excited Power Factor	0.001	40286	898	n/a	n/a	R
40247	U16	Apparent Power Max Rating	10 VA	40287	4000	n/a	n/a	R
40248	U16	Reactive Power Max Rating - Injected	10 VAR	40288	4000	n/a	n/a	R
40249	U16	Reactive Power Max Rating - Absorbed	10 VAR	40288	4000	n/a	n/a	R
40250	U16	Maximum Active Power Charge Rate	10 W	40285	4000	n/a	n/a	R
40251	U16	Maximum Active Power Discharge Rate	10 W	40285	4000	n/a	n/a	R

Number	Data Type	Description	Units ¹	Scale Factor (Reg #)	Factory Default	Min	Max	Access Level
40252	U16	Maximum Apparent Power Charge Rate	10 VA	40287	4000	n/a	n/a	R
40253	U16	Maximum Apparent Power Discharge Rate	10 VA	40287	4000	n/a	n/a	R
40254	U16	AC Voltage Nominal Rating	0.1 Vrms	40289	4800	n/a	n/a	R
40255	U16	AC Voltage Maximum Rating	0.1 Vrms	40289	5280	n/a	n/a	R
40256	U16	AC Voltage Minimum Rating	0.1 Vrms	40289	1830	n/a	n/a	R
40257	U16	AC Current Maximum Rating	0.1 A	40290	500	n/a	n/a	R
40258	U16	Power Factor Over-Excited Rating	0.001	40286	0	n/a	n/a	R
40259	U16	Power Factor Under-Excited Rating	0.001	40286	0	n/a	n/a	R
40260	U16	Reactive Susceptance When Disconnected	S	40291	0	n/a	n/a	R
40261	U16	Normal Operating Category: 0 = Category A; 1 = Category B	ENUM	n/a	1	n/a	n/a	R
40262	U16	Abnormal Operating Category: 0 = Category 1; 1 = Category 2; 2 = Category 3	ENUM	n/a	2	n/a	n/a	R
40263	U32	Supported Control Modes: Bit 0 = Max Watt Bit 1 = Fixed Watt Bit 2 = Fixed VAR Bit 3 = Fixed PF Bit 4 = Volt-VAR Bit 5 = Freq-Watt Bit 6 = Dynamic Reactive Current <i>(not supported)</i> Bit 7 = LVRT Bit 8 = HVRT Bit 9 = Watt-VAR Bit 10 = Volt-Watt Bit 11 = Scheduled <i>(not supported)</i> Bit 12 = LFRT Bit 13 = HFRT All Others = Reserved	Bitfield	n/a	0x37BF	n/a	n/a	R
40265	U16	Intentional Island Categories: Bit 0 = Uncategorized <i>(not supported)</i> Bit 1 = Intentional Island Capable Bit 2 = Black Start Capable Bit 3 = Isochronous Capable All Others = Reserved	Bitfield	n/a	0x000E	n/a	n/a	R
40266	U16	Setting for Maximum Active Power (W_{MAX})	10 W	40285	4000	100	4000	RWO
40271	U16	Setting for Maximum Apparent Power (VA_{MAX})	10 VA	40287	4000	100	4000	RWO
40272	U16	Setting for Maximum Injected Reactive Power (VAR_{MAX}) - see Note 2 below	10 VAR	40288	4000 ²	0	4000	RWO
40273	U16	Setting for Maximum Absorbed Reactive Power (VAR_{MAX}) - see Note 2 below	10 VAR	40288	4000 ²	0	4000	RWO
40278	U16	Nominal AC Voltage Setting (V_{NOM})	0.1 Vrms	40289	4800	2080	4800	RWO
40281	U16	Setting for Maximum AC Current	0.1 A	40290	500	0	500	RWO
40285	S16	Scale Factor - Active Power	sunssf	n/a	1	n/a	n/a	R
40286	S16	Scale Factor - Power Factor	sunssf	n/a	-3	n/a	n/a	R
40287	S16	Scale Factor - Apparent Power	sunssf	n/a	1	n/a	n/a	R

Number	Data Type	Description	Units ¹	Scale Factor (Reg #)	Factory Default	Min	Max	Access Level
40288	S16	Scale Factor - Reactive Power	sunssf	n/a	1	n/a	n/a	R
40289	S16	Scale Factor - AC Voltage	sunssf	n/a	-1	n/a	n/a	R
40290	S16	Scale Factor - AC Current	sunssf	n/a	-1	n/a	n/a	R
40291	S16	Scale Factor - Susceptance	sunssf	n/a	0	n/a	n/a	R

¹ Units include applied scale factor register

² The PCS does not provide independent settings for maximum injected versus absorbed reactive power – values written to 40272 will also be written to 40273 and vice versa

11.3.6 SunSpec Model 703 Registers – Enter Service

Number	Data Type	Description	Units ¹	Scale Factor (Reg #)	Factory Default	Min	Max	Access Level
Header:								
40292	U16	Model Identifier	n/a	n/a	703	n/a	n/a	R
40293	U16	Model Length - # of 16-bit registers to follow	n/a	n/a	17	n/a	n/a	R
Fixed Block:								
40294	U16	Permit Enter Service: 0 = Disabled; 1 = Enabled	ENUM	n/a	1	0	1	RW
40295	U16	Enter Service High Voltage Threshold (%V _{NOM} , REG 40278)	0.1 %	40309	1050	1000	1200	RW
40296	U16	Enter Service Low Voltage Threshold (%V _{NOM} , REG 40278)	0.1 %	40309	917	0	1000	RW
40297	U32	Enter Service High Frequency Threshold	0.01 Hz	40310	6010	5000	9000	RW
40299	U32	Enter Service Low Frequency Threshold	0.01 Hz	40310	5950	3000	6000	RW
40301	U32	Enter Service Delay Time	sec	n/a	300	0	3600	RW
40303	U32	Enter Service Random Delay	sec	n/a	0	0	3600	RW
40305	U32	Enter Service Ramp Time	sec	n/a	300	1	3600	RW
40307	U32	Enter Service Delay Time Remaining	sec	n/a	0	n/a	n/a	R
40309	S16	Scale Factor - AC Voltage (%V _{NOM})	sunssf	n/a	-1	n/a	n/a	R
40310	S16	Scale Factor - AC Frequency	sunssf	n/a	-2	n/a	n/a	R

¹ Units include applied scale factor register

11.3.7 SunSpec Model 704 Registers – DER AC Controls

Number	Data Type	Description	Units ¹	Scale Factor (Reg #)	Factory Default	Min	Max	Access Level
Header:								
40311	U16	Model Identifier	n/a	n/a	704	n/a	n/a	R
40312	U16	Model Length - # of 16-bit registers to follow	n/a	n/a	65	n/a	n/a	R
Fixed Block:								
40313	U16	Power Factor Enable - Injecting Watts (<i>see Note 2 below</i>): 0 = Disabled; 1 = Enabled	ENUM	n/a	1 ²	0	1	RW
40319	U16	Power Factor Enable - Absorbing Watts (<i>see Note 2 below</i>): 0 = Disabled; 1 = Enabled	ENUM	n/a	1 ²	0	1	RW
40325	U16	Limit Max Active Power Percent Enable: 0 = Disabled; 1 = Enabled	ENUM	n/a	0	0	1	RW
40326	U16	Limit Max Active Power Percent Setpoint	0.1 %W _{MAX}	40365	1000	0	1000	RW
40333	U16	Set Active Power Enable: 0 = Disabled; 1 = Enabled	ENUM	n/a	1	0	1	RW
40339	S16	Set Active Power Percent Setpoint ³	0.1 % W _{MAX}	40367	0	-1000	1000	RW
40346	U16	Set Reactive Power Enable: 0 = Disabled; 1 = Enabled	ENUM	n/a	0	0	1	RW
40347	U16	Set Reactive Power Mode: 0 = % Max Watts (REG 40266) 1 = % Max VARs (REG 40272) 2 = % Available VAR (<i>not supported, behaves like setting '1'</i>) 3 = % Max VA (REG 40271) 4 = units of VAR (<i>not supported</i>)	ENUM	n/a	1	0	3	RW
40348	U16	Set Reactive Power Priority: 0 = Active Power Priority 1 = Reactive Power Priority 2 = Vendor Specific (<i>not supported</i>)	ENUM	n/a	1	0	1	RW
40353	S16	Set Reactive Power Percent Setpoint ⁴	0.1 %VAR _{MAX}	40369	0	-1000	1000	RW
40360	U16	Active Power Ramp Rate	%W _{MAX} /s	n/a	100	1	1000	RW
40362	U16	Reactive Power Ramp Rate	%VAR _{MAX} /s	n/a	100	1	1000	RW
40363	U16	Anti-Islanding Enable: 0 = Disabled; 1 = Enabled	ENUM	n/a	1	0	1	RW
40364	S16	Scale Factor - Power Factor	sunssf	n/a	-3	n/a	n/a	R
40365	S16	Scale Factor - Limit Max Active Power Percent	sunssf	n/a	-1	n/a	n/a	R
40367	S16	Scale Factor - Active Power Percent	sunssf	n/a	-1	n/a	n/a	R

Number	Data Type	Description	Units ¹	Scale Factor (Reg #)	Factory Default	Min	Max	Access Level
40369	S16	Scale Factor - Reactive Power Percent	sunssf	n/a	-1	n/a	n/a	R
40370	U16	Power Factor Setpoint When Injecting Watts	n/a	40364	1000	0	1000	RW
40371	U16	Power Factor Excitation When Injecting Watts: 0 = Over Excited 1 = Under Excited	ENUM	n/a	0	0	1	RW
40374	U16	Power Factor Setpoint When Absorbing Watts	n/a	40364	1000	0	1000	RW
40375	U16	Power Factor Excitation When Absorbing Watts 0 = Over Excited 1 = Under Excited	ENUM	n/a	0	0	1	RW

¹ Units include applied scale factor register

² The PCS does not provide independent Power Factor Enables for Injecting versus Absorbing active power – values written to 40313 will also be written to 40319 and vice versa

³ Positive value indicates active power delivered to the grid

⁴ Positive value indicates reactive power delivered to the grid (over-excited, phase current lags phase voltage)

11.3.8 SunSpec Model 705 Registers – DER Volt-VAR

Number	Data Type	Description	Units ¹	Scale Factor (Reg #)	Factory Default	Min	Max	Access Level
Header:								
40378	U16	Model Identifier	n/a	n/a	705	n/a	n/a	R
40379	U16	Model Length - # of 16-bit registers to follow	n/a	n/a	73	n/a	n/a	R
Fixed Block:								
40380	U16	Volt-VAR Module Enable: 0 = Disabled; 1 = Enabled	ENUM	n/a	0	0	1	RW
40381	U16	Volt-VAR Adopt Curve Request	n/a	n/a	2	1	2	RW
40382	U16	Volt-VAR Adopt Curve Result: 0 = In Progress; 1 = Completed; 2 = Failed	ENUM	n/a	n/a	n/a	n/a	R
40383	U16	Volt-VAR Number of Curve Points Supported	n/a	n/a	10	n/a	n/a	R
40384	U16	Volt-VAR Number of Curves Supported	n/a	n/a	2	n/a	n/a	R
40390	S16	Volt-VAR Scale Factor - Voltage (%V _{NOM})	sunssf	n/a	-2	n/a	n/a	R
40391	S16	Volt-VAR Scale Factor - Reactive Power (%MAX)	sunssf	n/a	-2	n/a	n/a	R
40392	S16	Volt-VAR Scale Factor - Response Time	sunssf	n/a	-3	n/a	n/a	R

Number	Data Type	Description	Units ¹	Scale Factor (Reg #)	Factory Default	Min	Max	Access Level
Repeating Block #1:								
40393	U16	Volt-VAR Curve 1: Number of Active Points in Array	n/a	n/a	4	n/a	n/a	R
40394	U16	Volt-VAR Curve 1: VAR Dependent Reference: 0 = % Max Watts (REG 40266) 1 = % Max VARs (REG 40272) 2 = % Available VAR (<i>not supported, behaves like setting '1'</i>) 3 = % Max VA (REG 40271)	ENUM	n/a	1	n/a	n/a	R
40395	U16	Volt-VAR Curve 1: Power Priority: 0 = Active Power Priority 1 = Reactive Power Priority 2 = Vendor Specific (<i>not supported</i>)	ENUM	n/a	1	n/a	n/a	R
40396	U16	Volt-VAR Curve 1: Vref Adjustment (%V _{NOM} , REG 40278)	0.01 %	40390	10000	n/a	n/a	R
40397	U16	Volt-VAR Curve 1: Current Autonomous Vref (%V _{NOM} , REG 40278)	0.01 %	40390	n/a	n/a	n/a	R
40398	U16	Volt-VAR Curve 1: Autonomous Vref Enable: 0 = Disabled; 1 = Enabled	ENUM	n/a	0	n/a	n/a	R
40399	U16	Volt-VAR Curve 1: Autonomous Vref Time Constant	sec	n/a	300	n/a	n/a	R
40400	U32	Volt-VAR Curve 1: Response Time	0.001 sec	40392	5000	n/a	n/a	R
40402	U16	Volt-VAR Curve 1: Read Only: 0 = Read/Write; 1 = Read Only	ENUM	n/a	1	n/a	n/a	R
40403	U16	Volt-VAR Curve 1: Point 1 – Voltage (%V _{NOM} , REG 40278)	0.01 %	40390	9200	n/a	n/a	R
40404	S16	Volt-VAR Curve 1: Point 1 – VAR (%MAX, see REG 40394)	0.01 %	40391	4400	n/a	n/a	R
40405	U16	Volt-VAR Curve 1: Point 2 – Voltage (%V _{NOM} , REG 40278)	0.01 %	40390	9800	n/a	n/a	R
40406	S16	Volt-VAR Curve 1: Point 2 – VAR (%MAX, see REG 40394)	0.01 %	40391	0	n/a	n/a	R
40407	U16	Volt-VAR Curve 1: Point 3 – Voltage (%V _{NOM} , REG 40278)	0.01 %	40390	10200	n/a	n/a	R
40408	S16	Volt-VAR Curve 1: Point 3 – VAR (%MAX, see REG 40394)	0.01 %	40391	0	n/a	n/a	R
40409	U16	Volt-VAR Curve 1: Point 4 – Voltage (%V _{NOM} , REG 40278)	0.01 %	40390	10800	n/a	n/a	R
40410	S16	Volt-VAR Curve 1: Point 4 – VAR (%MAX, see REG 40394)	0.01 %	40391	-4400	n/a	n/a	R
40411-	U16	Volt-VAR Curve 1: Points 5 thru 10 – Voltage (%V _{NOM} , REG 40278)	0.01 %	40390	10000	n/a	n/a	R
40422	S16	Volt-VAR Curve 1: Points 5 thru 10 – VAR (%MAX, see REG 40394)	0.01 %	40391	0	n/a	n/a	R
Repeating Block #2:								
40423	U16	Volt-VAR Curve 2: Number of Active Points in Array	n/a	n/a	Note ²	1	10	RW

Number	Data Type	Description	Units ¹	Scale Factor (Reg #)	Factory Default	Min	Max	Access Level
40424	U16	Volt-VAR Curve 2: VAR Dependent Reference: 0 = % Max Watts (REG 40266) 1 = % Max VARs (REG 40272) 2 = % Available VAR (<i>not supported, behaves like setting '1'</i>) 3 = % Max VA (REG 40271)	ENUM	n/a	Note ²	0	3	RW
40425	U16	Volt-VAR Curve 2: Power Priority: 0 = Active Power Priority 1 = Reactive Power Priority 2 = Vendor Specific (<i>not supported</i>)	ENUM	n/a	Note ²	0	1	RW
40426	U16	Volt-VAR Curve 2: Vref Adjustment (%V _{NOM} , REG 40278)	0.01 %	40390	Note ²	9500	10500	RW
40427	U16	Volt-VAR Curve 2: Current Autonomous Vref (%V _{NOM} , REG 40278)	0.01 %	40390	n/a	n/a	n/a	R
40428	U16	Volt-VAR Curve 2: Autonomous Vref Enable: 0 = Disabled; 1 = Enabled	ENUM	n/a	Note ²	0	1	RW
40429	U16	Volt-VAR Curve 2: Autonomous Vref Time Constant	sec	n/a	Note ²	1	10000	RW
40430	U32	Volt-VAR Curve 2: Response Time	0.001 sec	40392	Note ²	1000	90000	RW
40432	U16	Volt-VAR Curve 2: Read Only: 0 = Read/Write; 1 = Read Only	ENUM	n/a	0	n/a	n/a	R
40433-	U16	Volt-VAR Curve 2: Points 1 thru 10 – Voltage (%V _{NOM} , REG 40278)	0.01 %	40390	Note ²	8000	12000	RW
40452	S16	Volt-VAR Curve 2: Points 1 thru 10 – VAR (%MAX, see REG 40424)	0.01 %	40391	Note ²	-10000	10000	RW

¹ Units include applied scale factor register

² Curve 2 data defaults to the latest Curve 1 values at POR - see section 11.2 for details on how to manage curve settings

11.3.9 SunSpec Model 706 Registers – DER Volt-Watt

Number	Data Type	Description	Units ¹	Scale Factor (Reg #)	Factory Default	Min	Max	Access Level
Header:								
40453	U16	Model Identifier	n/a	n/a	706	n/a	n/a	R
40454	U16	Model Length - # of 16-bit registers to follow	n/a	n/a	63	n/a	n/a	R
Fixed Block:								
40455	U16	Volt-Watt Module Enable: 0 = Disabled; 1 = Enabled	ENUM	n/a	0	0	1	RW
40456	U16	Volt-Watt Adopt Curve Request	n/a	n/a	2	1	2	RW

Number	Data Type	Description	Units ¹	Scale Factor (Reg #)	Factory Default	Min	Max	Access Level
40457	U16	Volt-Watt Adopt Curve Result: 0 = In Progress; 1 = Completed, 2 = Failed	ENUM	n/a	n/a	n/a	n/a	R
40458	U16	Volt-Watt Number of Curve Points Supported	n/a	n/a	10	n/a	n/a	R
40459	U16	Volt-Watt Number of Curves Supported	n/a	n/a	2	n/a	n/a	R
40465	S16	Volt-Watt Scale Factor - Voltage (%V _{NOM})	sunssf	n/a	-2	n/a	n/a	R
40466	S16	Volt-Watt Scale Factor - Active Power (%W _{MAX})	sunssf	n/a	-2	n/a	n/a	R
40467	S16	Volt-Watt Scale Factor - Response Time	sunssf	n/a	-3	n/a	n/a	R
Repeating Block #1:								
40468	U16	Volt-Watt Curve 1: Number of Active Points in Array	n/a	n/a	2	n/a	n/a	R
40469	U16	Volt-Watt Curve 1: Dependent Variable: 0 = %W _{MAX} (REG 40266)	ENUM	n/a	0	n/a	n/a	R
40470	U32	Volt-Watt Curve 1: Response Time	0.001 sec	40467	10000	n/a	n/a	R
40472	U16	Volt-Watt Curve 1: Read Only: 0 = Read/Write; 1 = Read Only	ENUM	n/a	1	n/a	n/a	R
40473	U16	Volt-Watt Curve 1: Point 1 – Voltage (%V _{NOM} , REG 40278)	0.01 %	40465	10600	n/a	n/a	R
40474	S16	Volt-Watt Curve 1: Point 1 – Watts (%W _{MAX} , REG 40266)	0.01 %	40466	10000	n/a	n/a	R
40475	U16	Volt-Watt Curve 1: Point 2 – Voltage (%V _{NOM} , REG 40278)	0.01 %	40465	11000	n/a	n/a	R
40476	S16	Volt-Watt Curve 1: Point 2 – Watts (%W _{MAX} , REG 40266)	0.01 %	40466	0	n/a	n/a	R
40477-	U16	Volt-Watt Curve 1: Points 3 thru 10 – Voltage (%V _{NOM} , REG 40278)	0.01 %	40465	10000	n/a	n/a	R
40492	S16	Volt-Watt Curve 1: Points 3 thru 10 – Watts (%W _{MAX} , REG 40266)	0.01 %	40466	0	n/a	n/a	R
Repeating Block #2:								
40493	U16	Volt-Watt Curve 2: Number of Active Points in Array	n/a	n/a	Note ²	2	10	RW
40494	U16	Volt-Watt Curve 2: Dependent Variable: 0 = %W _{MAX} (REG 40266)	ENUM	n/a	0	0	0	RW
40495	U32	Volt-Watt Curve 2: Response Time	0.001 sec	40468	Note ²	500	60000	RW
40497	U16	Volt-Watt Curve 2: Read Only: 0 = Read/Write; 1 = Read Only	ENUM	n/a	0	n/a	n/a	R
40498-	U16	Volt-Watt Curve 2: Points 1 thru 10 – Voltage (%V _{NOM} , REG 40278)	0.01 %	40465	Note ²	10000	12000	RW
40517	S16	Volt-Watt Curve 2: Points 1 thru 10 – Watts (%W _{MAX} , REG 40266)	0.01 %	40466	Note ²	-10000	10000	RW

¹ Units include applied scale factor register

² Curve 2 data defaults to the latest Curve 1 values at POR - see section 11.2 for details on how to manage curve settings

11.3.10 SunSpec Model 707 Registers – DER Low Voltage Trip (LVRT)

Number	Data Type	Description	Units ¹	Scale Factor (Reg #)	Factory Default	Min	Max	Access Level
Header:								
40518	U16	Model Identifier	n/a	n/a	707	n/a	n/a	R
40519	U16	Model Length - # of 16-bit registers to follow	n/a	n/a	231	n/a	n/a	R
Fixed Block:								
40520	U16	LVRT Module Enable: 0 = Disable, 1 = Enable Note: If disabled, then REG 41820 “Default Grid Low Voltage Threshold” is used to define the immediate disconnect threshold	ENUM	n/a	1	0	1	RW
40521	U16	LVRT Adopt Curve Request	n/a	n/a	2	1	2	RW
40522	U16	LVRT Adopt Curve Result: 0 = In Progress; 1 = Completed, 2 = Failed	ENUM	n/a	n/a	n/a	n/a	R
40523	U16	LVRT Number of Curve Points Supported	n/a	n/a	12	n/a	n/a	R
40524	U16	LVRT Number of Curves Supported	n/a	n/a	2	n/a	n/a	R
40525	S16	LVRT Scale Factor - Voltage (%V _{NOM} , REG 40278)	sunssf	n/a	-1	n/a	n/a	R
40526	S16	LVRT Scale Factor - Duration	sunssf	n/a	-2	n/a	n/a	R
Repeating Block #1:								
40527	U16	LVRT Curve 1: 0 = Read/Write; 1 = Read Only	n/a	n/a	1	n/a	n/a	R
Curve 1: Must Trip Data								
40528	U16	LVRT Must Trip Curve 1: Number of Active Points in Array	n/a	n/a	5	n/a	n/a	R
40529	U16	LVRT Must Trip Curve 1: Point 1 – Voltage (%V _{NOM})	0.1 %	40525	0	n/a	n/a	R
40530	U32	LVRT Must Trip Curve 1: Point 1 – Duration	0.01 Sec	40526	200	n/a	n/a	R
40532	U16	LVRT Must Trip Curve 1: Point 2 – Voltage (%V _{NOM})	0.1 %	40525	500	n/a	n/a	R
40533	U32	LVRT Must Trip Curve 1: Point 2 – Duration	0.01 Sec	40526	200	n/a	n/a	R
40535	U16	LVRT Must Trip Curve 1: Point 3 – Voltage (%V _{NOM})	0.1 %	40525	500	n/a	n/a	R
40536	U32	LVRT Must Trip Curve 1: Point 3 – Duration	0.01 Sec	40526	2100	n/a	n/a	R
40538	U16	LVRT Must Trip Curve 1: Point 4 – Voltage (%V _{NOM})	0.1 %	40525	880	n/a	n/a	R
40539	U32	LVRT Must Trip Curve 1: Point 4 – Duration	0.01 Sec	40526	2100	n/a	n/a	R
40541	U16	LVRT Must Trip Curve 1: Point 5 – Voltage (%V _{NOM})	0.1 %	40525	880	n/a	n/a	R
40542	U32	LVRT Must Trip Curve 1: Point 5 – Duration	0.01 Sec	40526	2200	n/a	n/a	R
40544-	U16	LVRT Must Trip Curve 1: Points 6 thru 12 – Voltage (%V _{NOM})	0.1 %	40525	0	n/a	n/a	R
40563	U32	LVRT Must Trip Curve 1: Points 6 thru 12 – Duration	0.01 Sec	40526	0	n/a	n/a	R

Number	Data Type	Description	Units ¹	Scale Factor (Reg #)	Factory Default	Min	Max	Access Level
Curve 1: Momentary Cessation Data								
40602	U16	LVRT Momentary Cessation Curve 1: Number of Active Points	n/a	n/a	2	n/a	n/a	R
40603	U16	LVRT Momentary Cessation Curve 1: Point 1 – Voltage (%V _{NOM})	0.1 %	40525	500	n/a	n/a	R
40604	U16	LVRT Momentary Cessation Curve 1: Point 1 – Duration	0.01 sec	40526	0	n/a	n/a	R
40606	U16	LVRT Momentary Cessation Curve 1: Point 2 – Voltage (%V _{NOM})	0.1 %	40525	500	n/a	n/a	R
40607	U16	LVRT Momentary Cessation Curve 1: Point 2 – Duration	0.01 sec	40526	100	n/a	n/a	R
40609-	U16	LVRT Momentary Cessation Curve 1: Points 3 thru 12 – Voltage (%V _{NOM})	0.1 %	40525	0	n/a	n/a	R
40637	U32	LVRT Momentary Cessation Curve 1: Points 3 thru 12 – Duration	0.01 Sec	40526	0	n/a	n/a	R
Repeating Block #2:								
40639	U16	LVRT Curve 2: 0 = Read/Write; 1 = Read Only	n/a	n/a	0	n/a	n/a	R
Curve 2: Must Trip Data								
40640	U16	LVRT Must Trip Curve 2: Number of Active Points in Array	n/a	n/a	Note ²	2	12	RW
40641-	U16	LVRT Must Trip Curve 2: Points 1 thru 12 – Voltage (%V _{NOM})	0.1 %	40525	Note ²	0	1000	RW
40675	U32	LVRT Must Trip Curve 2: Points 1 thru 12 – Duration	0.01 Sec	40526	Note ²	0	120000	RW
Curve 2: Momentary Cessation Data								
40714	U16	LVRT Momentary Cessation Curve 2: Number of Active Points in Array	n/a	n/a	Note ²	2	12	RW
40715-	U16	LVRT Momentary Cessation Curve 2: Points 1 thru 12 – Voltage (%V _{NOM})	0.1 %	40525	Note ²	0	1000	RW
40749	U32	LVRT Momentary Cessation Curve 2: Points 1 thru 12 – Duration	0.01 Sec	40526	Note ²	0	120000	RW

¹ Units include applied scale factor register

² Curve 2 data defaults to the latest Curve 1 values at POR - see section 11.2 for details on how to manage curve settings

11.3.11 SunSpec Model 708 Registers – DER High Voltage Trip (HVRT)

Number	Data Type	Description	Units ¹	Scale Factor (Reg #)	Factory Default	Min	Max	Access Level
Header:								
40751	U16	Model Identifier	n/a	n/a	708	n/a	n/a	R
40752	U16	Model Length - # of 16-bit registers to follow	n/a	n/a	231	n/a	n/a	R
Fixed Block:								

Number	Data Type	Description	Units ¹	Scale Factor (Reg #)	Factory Default	Min	Max	Access Level
40753	U16	HVRT Module Enable: 0 = Disable, 1 = Enable Note: If disabled, then REG 41819 “Default Grid High Voltage Threshold” is used to define the immediate disconnect threshold	ENUM	n/a	1	0	1	RW
40754	U16	HVRT Adopt Curve Request	n/a	n/a	2	1	2	RW
40755	U16	HVRT Adopt Curve Result: 0 = In Progress; 1 = Completed, 2 = Failed	ENUM	n/a	n/a	n/a	n/a	R
40756	U16	HVRT Number of Curve Points Supported	n/a	n/a	12	n/a	n/a	R
40757	U16	HVRT Number of Curves Supported	n/a	n/a	2	n/a	n/a	R
40758	S16	HVRT Scale Factor - Voltage (%V _{NOM} , REG 40278)	sunssf	n/a	-1	n/a	n/a	R
40759	S16	HVRT Scale Factor - Duration	sunssf	n/a	-2	n/a	n/a	R
Repeating Block #1:								
40760	U16	HVRT Curve 1: 0 = Read/Write; 1 = Read Only	n/a	n/a	1	n/a	n/a	R
Curve 1: Must Trip Data								
40761	U16	HVRT Must Trip Curve 1: Number of Active Points in Array	n/a	n/a	5	n/a	n/a	R
40762	U16	HVRT Must Trip Curve 1: Point 1 – Voltage (%V _{NOM})	0.1 %	40758	1210	n/a	n/a	R
40763	U32	HVRT Must Trip Curve 1: Point 1 – Duration	0.01 Sec	40759	16	n/a	n/a	R
40765	U16	HVRT Must Trip Curve 1: Point 2 – Voltage (%V _{NOM})	0.1 %	40758	1200	n/a	n/a	R
40766	U32	HVRT Must Trip Curve 1: Point 2 – Duration	0.01 Sec	40759	16	n/a	n/a	R
40768	U16	HVRT Must Trip Curve 1: Point 3 – Voltage (%V _{NOM})	0.1 %	40758	1200	n/a	n/a	R
40769	U32	HVRT Must Trip Curve 1: Point 3 – Duration	0.01 Sec	40759	1300	n/a	n/a	R
40771	U16	HVRT Must Trip Curve 1: Point 4 – Voltage (%V _{NOM})	0.1 %	40758	1100	n/a	n/a	R
40772	U32	HVRT Must Trip Curve 1: Point 4 – Duration	0.01 Sec	40759	1300	n/a	n/a	R
40774	U16	HVRT Must Trip Curve 1: Point 5 – Voltage (%V _{NOM})	0.1 %	40758	1100	n/a	n/a	R
40775	U32	HVRT Must Trip Curve 1: Point 5 – Duration	0.01 Sec	40759	1400	n/a	n/a	R
40777-40796	U16	HVRT Must Trip Curve 1: Points 6 thru 12 – Voltage (%V _{NOM})	0.1 %	40758	1000	n/a	n/a	R
	U32	HVRT Must Trip Curve 1: Points 6 thru 12 – Duration	0.01 Sec	40759	0	n/a	n/a	R
Curve 1: Momentary Cessation Data								
40835	U16	HVRT Momentary Cessation Curve 1: Number of Active Points	n/a	n/a	2	n/a	n/a	R
40836	U32	HVRT Momentary Cessation Curve 1: Point 1 - Voltage (%V _{NOM})	0.1 %	40758	1100	n/a	n/a	R
40837	U16	HVRT Momentary Cessation Curve 1: Point 1 - Duration	0.01 sec	40759	0	n/a	n/a	R
40839	U32	HVRT Momentary Cessation Curve 1: Point 2 - Voltage (%V _{NOM})	0.1 %	40758	1100	n/a	n/a	R
40840	U16	HVRT Momentary Cessation Curve 1: Point 2 - Duration	0.01 sec	40759	1200	n/a	n/a	R

Number	Data Type	Description	Units ¹	Scale Factor (Reg #)	Factory Default	Min	Max	Access Level
40842-	U32	HVRT Momentary Cessation Curve 1: Points 3 thru 12 – Voltage (%V _{NOM})	0.1 %	40758	1000	n/a	n/a	R
40870	U16	HVRT Momentary Cessation Curve 1: Points 3 thru 12 – Duration	0.01 Sec	40759	0	n/a	n/a	R
Repeating Block #2:								
40872	U16	HVRT Curve 2: 0 = Read/Write; 1 = Read Only	n/a	n/a	0	n/a	n/a	R
Curve 2: Must Trip Data								
40873	U16	HVRT Must Trip Curve 2: Number of Active Points in Array	n/a	n/a	Note ²	2	12	RW
40874-	U16	HVRT Must Trip Curve 2: Points 1 thru 12 – Voltage (%V _{NOM})	0.1 %	40758	Note ²	1000	1300	RW
40908	U32	HVRT Must Trip Curve 2: Points 1 thru 12 – Duration	0.01 Sec	40759	Note ²	0	120000	RW
Curve 2: Momentary Cessation Data								
40947	U16	HVRT Momentary Cessation Curve 2: Number of Active Points in Array	n/a	n/a	Note ²	2	12	RW
40948-	U16	HVRT Momentary Cessation Curve 2: Points 1 thru 12 – Voltage (%V _{NOM})	0.1 %	40758	Note ²	1000	1300	RW
40982	U32	HVRT Momentary Cessation Curve 2: Points 1 thru 12 – Duration	0.01 Sec	40759	Note ²	0	120000	RW

¹ Units include applied scale factor register

² Curve 2 data defaults to the latest Curve 1 values at POR - see section 11.2 for details on how to manage curve settings

11.3.12 SunSpec Model 709 Registers – DER Low Frequency Trip (LFRT)

Number	Data Type	Description	Units ¹	Scale Factor (Reg #)	Factory Default	Min	Max	Access Level
Header:								
40984	U16	Model Identifier	n/a	n/a	709	n/a	n/a	R
40985	U16	Model Length - # of 16-bit registers to follow	n/a	n/a	303	n/a	n/a	R
Fixed Block:								
40986	U16	LFRT Module Enable: 0 = Disable, 1 = Enable Note: If disabled, then REG 41822 “Default Grid Low Frequency Threshold” is used to define the immediate disconnect threshold	ENUM	n/a	1	0	1	RW
40987	U16	LFRT Adopt Curve Request	n/a	n/a	2	1	2	RW
40988	U16	LFRT Adopt Curve Result: 0 = In Progress; 1 = Completed, 2 = Failed	ENUM	n/a	n/a	n/a	n/a	R
40989	U16	LFRT Number of Curve Points Supported	n/a	n/a	12	n/a	n/a	R
40990	U16	LFRT Number of Curves Supported	n/a	n/a	2	n/a	n/a	R

Number	Data Type	Description	Units ¹	Scale Factor (Reg #)	Factory Default	Min	Max	Access Level
40991	S16	LFRT Scale Factor - Frequency	sunssf	n/a	-2	n/a	n/a	R
40992	S16	LFRT Scale Factor - Duration	sunssf	n/a	-2	n/a	n/a	R
Repeating Block #1:								
40993	U16	LFRT Curve 1: 0 = Read/Write; 1 = Read Only	n/a	n/a	1	n/a	n/a	R
Curve 1: Must Trip Data								
40994	U16	LFRT Must Trip Curve 1: Number of Active Points in Array	n/a	n/a	5	n/a	n/a	R
40995	U32	LFRT Must Trip Curve 1: Point 1 – Frequency	0.01 Hz	40991	5000	n/a	n/a	R
40997	U32	LFRT Must Trip Curve 1: Point 1 – Duration	0.01 Sec	40992	16	n/a	n/a	R
40999	U32	LFRT Must Trip Curve 1: Point 2 – Frequency	0.01 Hz	40991	5650	n/a	n/a	R
41001	U32	LFRT Must Trip Curve 1: Point 2 – Duration	0.01 Sec	40992	16	n/a	n/a	R
41003	U32	LFRT Must Trip Curve 1: Point 3 – Frequency	0.01 Hz	40991	5650	n/a	n/a	R
41005	U32	LFRT Must Trip Curve 1: Point 3 – Duration	0.01 Sec	40992	30000	n/a	n/a	R
41007	U32	LFRT Must Trip Curve 1: Point 4 – Frequency	0.01 Hz	40991	5850	n/a	n/a	R
41009	U32	LFRT Must Trip Curve 1: Point 4 – Duration	0.01 Sec	40992	30000	n/a	n/a	R
41011	U32	LFRT Must Trip Curve 1: Point 5 – Frequency	0.01 Hz	40991	5850	n/a	n/a	R
41013	U32	LFRT Must Trip Curve 1: Point 5 – Duration	0.01 Sec	40992	40000	n/a	n/a	R
41015 -	U32	LFRT Must Trip Curve 1: Points 6 thru 12 – Frequency	0.01 Hz	40991	4000	n/a	n/a	R
41041	U32	LFRT Must Trip Curve 1: Points 6 thru 12 – Duration	0.01 Sec	40992	0	n/a	n/a	R
Curve 1: Momentary Cessation Data								
41092	U16	LFRT Momentary Cessation Curve 1: Number of Active Points	n/a	n/a	2	n/a	n/a	R
41093	U32	LFRT Momentary Cessation Curve 1: Point 1 – Frequency	0.01 Hz	40991	4000	n/a	n/a	R
41095	U32	LFRT Momentary Cessation Curve 1: Point 1 – Duration	0.01 Sec	40992	0	n/a	n/a	R
41097	U32	LFRT Momentary Cessation Curve 1: Point 2 – Frequency	0.01 Hz	40991	4000	n/a	n/a	R
41099	U32	LFRT Momentary Cessation Curve 1: Point 2 – Duration	0.01 Sec	40992	30000	n/a	n/a	R
41101 -	U32	LFRT Momentary Cessation Curve 1: Points 3 thru 12 – Frequency	0.01 Hz	40991	4000	n/a	n/a	R
41139	U32	LFRT Momentary Cessation Curve 1: Points 3 thru 12 – Duration	0.01 Sec	40992	0	n/a	n/a	R
Repeating Block #2:								
41141	U16	LFRT Curve 2: 0 = Read/Write; 1 = Read Only	n/a	n/a	0	n/a	n/a	R
Curve 2: Must Trip Data								
41142	U16	LFRT Must Trip Curve 2: Number of Active Points in Array	n/a	n/a	Note ²	2	12	RW
	U32	LFRT Must Trip Curve 2: Points 1 thru 12 – Frequency	0.01 Hz	40991	Note ²	4000	6000	RW

Number	Data Type	Description	Units ¹	Scale Factor (Reg #)	Factory Default	Min	Max	Access Level
41143 - 41189	U32	LFRT Must Trip Curve 2: Points 1 thru 12 – Duration	0.01 Sec	40992	Note ²	0	120000	RW
Curve 2: Momentary Cessation Data								
41240	U16	LFRT Momentary Cessation Curve 2: Number of Active Points in Array	n/a	n/a	Note ²	2	12	RW
41241 - 41287	U32	LFRT Momentary Cessation Curve 2: Points 1 thru 12 – Frequency	0.01 Hz	40991	Note ²	4000	6000	RW
	U32	LFRT Momentary Cessation Curve 2: Points 1 thru 12 – Duration	0.01 Sec	40992	Note ²	0	120000	RW

¹ Units include applied scale factor register

² Curve 2 data defaults to the latest Curve 1 values at POR - see section 11.2 for details on how to manage curve settings

11.3.13 SunSpec Model 710 Registers – DER High Frequency Trip (HFRT)

Number	Data Type	Description	Units ¹	Scale Factor (Reg #)	Factory Default	Min	Max	Access Level
Header:								
41289	U16	Model Identifier	n/a	n/a	710	n/a	n/a	R
41290	U16	Model Length - # of 16-bit registers to follow	n/a	n/a	303	n/a	n/a	R
Fixed Block:								
41291	U16	HFRT Module Enable: 0 = Disable, 1 = Enable Note: If disabled, then REG 41821 “Default Grid High Frequency Threshold” is used to define the immediate disconnect threshold	ENUM	n/a	1	0	1	RW
41292	U16	HFRT Adopt Curve Request	n/a	n/a	2	1	2	RW
41293	U16	HFRT Adopt Curve Result: 0 = In Progress; 1 = Completed, 2 = Failed	ENUM	n/a	n/a	n/a	n/a	R
41294	U16	HFRT Number of Curve Points Supported	n/a	n/a	12	n/a	n/a	R
41295	U16	HFRT Number of Curves Supported	n/a	n/a	2	n/a	n/a	R
41296	S16	HFRT Scale Factor - Frequency	sunssf	n/a	-2	n/a	n/a	R
41297	S16	HFRT Scale Factor - Duration	sunssf	n/a	-2	n/a	n/a	R
Repeating Block #1:								
41298	U16	HFRT Curve 1: 0 = Read/Write; 1 = Read Only	n/a	n/a	1	n/a	n/a	R
Curve 1: Must Trip Data								
41299	U16	HFRT Must Trip Curve 1: Number of Active Points in Array	n/a	n/a	5	n/a	n/a	R
41300	U32	HFRT Must Trip Curve 1: Point 1 – Frequency	0.01 Hz	41296	6300	n/a	n/a	R

Number	Data Type	Description	Units ¹	Scale Factor (Reg #)	Factory Default	Min	Max	Access Level
41302	U32	HFRT Must Trip Curve 1: Point 1 – Duration	0.01 Sec	41297	16	n/a	n/a	R
41304	U32	HFRT Must Trip Curve 1: Point 2 – Frequency	0.01 Hz	41296	6200	n/a	n/a	R
41306	U32	HFRT Must Trip Curve 1: Point 2 – Duration	0.01 Sec	41297	16	n/a	n/a	R
41308	U32	HFRT Must Trip Curve 1: Point 3 – Frequency	0.01 Hz	41296	6200	n/a	n/a	R
41310	U32	HFRT Must Trip Curve 1: Point 3 – Duration	0.01 Sec	41297	30000	n/a	n/a	R
41312	U32	HFRT Must Trip Curve 1: Point 4 – Frequency	0.01 Hz	41296	6120	n/a	n/a	R
41314	U32	HFRT Must Trip Curve 1: Point 4 – Duration	0.01 Sec	41297	30000	n/a	n/a	R
41316	U32	HFRT Must Trip Curve 1: Point 5 – Frequency	0.01 Hz	41296	6120	n/a	n/a	R
41318	U32	HFRT Must Trip Curve 1: Point 5 – Duration	0.01 Sec	41297	40000	n/a	n/a	R
41320 -	U32	HFRT Must Trip Curve 1: Points 6 thru 12 – Frequency	0.01 Hz	41296	5000	n/a	n/a	R
41346	U32	HFRT Must Trip Curve 1: Points 6 thru 12 – Duration	0.01 Sec	41297	0	n/a	n/a	R
Curve 1: Momentary Cessation Data								
41397	U16	HFRT Momentary Cessation Curve 1: Number of Active Points	n/a	n/a	2	n/a	n/a	R
41398	U32	HFRT Momentary Cessation Curve 1: Point 1 – Frequency	0.01 Hz	41296	7000	n/a	n/a	R
41400	U32	HFRT Momentary Cessation Curve 1: Point 1 – Duration	0.01 Sec	41297	0	n/a	n/a	R
41402	U32	HFRT Momentary Cessation Curve 1: Point 2 – Frequency	0.01 Hz	41296	7000	n/a	n/a	R
41404	U32	HFRT Momentary Cessation Curve 1: Point 2 – Duration	0.01 Sec	41297	30000	n/a	n/a	R
41406 -	U32	HFRT Momentary Cessation Curve 1: Points 3 thru 12 – Frequency	0.01 Hz	41296	5000	n/a	n/a	R
41444	U32	HFRT Momentary Cessation Curve 1: Points 3 thru 12 – Duration	0.01 Sec	41297	0	n/a	n/a	R
Repeating Block #2:								
41446	U16	HFRT Curve 2: 0 = Read/Write; 1 = Read Only	n/a	n/a	0	n/a	n/a	R
Curve 2: Must Trip Data								
41447	U16	HFRT Must Trip Curve 2: Number of Active Points in Array	n/a	n/a	Note ²	2	12	RW
41448 -	U32	HFRT Must Trip Curve 2: Points 1 thru 12 – Frequency	0.01 Hz	41296	Note ²	5000	7000	RW
41494	U32	HFRT Must Trip Curve 2: Points 1 thru 12 – Duration	0.01 Sec	41297	Note ²	0	120000	RW
Curve 2: Momentary Cessation Data								
41545	U16	HFRT Momentary Cessation Curve 2: Number of Active Points in Array	n/a	n/a	Note ²	2	12	RW
41546 -	U32	HFRT Momentary Cessation Curve 2: Points 1 thru 12 – Frequency	0.01 Hz	41296	Note ²	5000	7000	RW
41592	U32	HFRT Momentary Cessation Curve 2: Points 1 thru 12 – Duration	0.01 Sec	41297	Note ²	0	120000	RW

¹ Units include applied scale factor register

² Curve 2 data defaults to the latest Curve 1 values at POR - see section 11.2 for details on how to manage curve settings

11.3.14 SunSpec Model 711 Registers – DER Frequency Droop (Freq-Watt)

Number	Data Type	Description	Units ¹	Scale Factor (Reg #)	Factory Default	Min	Max	Access Level
Header:								
41594	U16	Model Identifier	n/a	n/a	711	n/a	n/a	R
41595	U16	Model Length - # of 16-bit registers to follow	n/a	n/a	32	n/a	n/a	R
Fixed Block:								
41596	U16	Freq-Watt Module Enable: 0 = Disable, 1 = Enable	ENUM	n/a	1	0	1	RW
41597	U16	Freq-Watt Adopt Control Request	n/a	n/a	2	1	2	RW
41598	U16	Freq-Watt Adopt Control Result: 0 = In Progress; 1 = Completed, 2 = Failed	ENUM	n/a	n/a	n/a	n/a	R
41599	U16	Freq-Watt Number of Controls Supported	n/a	n/a	2	n/a	n/a	R
41605	S16	Freq-Watt Scale Factor - Frequency Deadband	sunssf	n/a	-3	n/a	n/a	R
41606	S16	Freq-Watt Scale Factor - Frequency Change Ratio	sunssf	n/a	-4	n/a	n/a	R
41607	S16	Freq-Watt Scale Factor - Response Time	sunssf	n/a	-3	n/a	n/a	R
Repeating Block #1:								
41608	U32	Freq-Watt Controller 1: Over-Frequency Deadband	0.001 Hz	41605	36	n/a	n/a	R
41610	U32	Freq-Watt Controller 1: Under-Frequency Deadband	0.001 Hz	41605	36	n/a	n/a	R
41612	U16	Freq-Watt Controller 1: Over-Frequency Change Ratio		41606	500	n/a	n/a	R
41613	U16	Freq-Watt Controller 1: Under-Frequency Change Ratio		41606	500	n/a	n/a	R
41614	U32	Freq-Watt Controller 1: Response Time	0.001 s	41607	5000	n/a	n/a	R
41616	S16	Freq-Watt Controller 1: Min Active Power (%W _{MAX} , REG 40266)	%	n/a	-100	n/a	n/a	R
41617	U16	Freq-Watt Controller 1: Read Only: 0 = Read/Write; 1 = Read Only	ENUM	n/a	1	n/a	n/a	R
Repeating Block #2:								
41618	U32	Freq-Watt Controller 2: Over-Frequency Deadband	0.001 Hz	41605	Note ²	10	10000	RW
41620	U32	Freq-Watt Controller 2: Under-Frequency Deadband	0.001 Hz	41605	Note ²	10	10000	RW
41622	U16	Freq-Watt Controller 2: Over-Frequency Change Ratio		41606	Note ²	100	5000	RW
41623	U16	Freq-Watt Controller 2: Under-Frequency Change Ratio		41606	Note ²	100	5000	RW
41624	U32	Freq-Watt Controller 2: Response Time	0.001 s	41607	Note ²	200	60000	RW
41626	S16	Freq-Watt Controller 2: Min Active Power (%W _{MAX} , REG 40266)	%	n/a	Note ²	-100	100	RW
41627	U16	Freq-Watt Controller 2: Read Only: 0 = Read/Write; 1 = Read Only	ENUM	n/a	0	n/a	n/a	R

¹ Units include applied scale factor register

² Controller 2 data defaults to the latest Controller 1 values at POR - see section 11.2 for details on how to manage controller settings

11.3.15 SunSpec Model 712 Registers – DER Watt-VAR

Number	Data Type	Description	Units ¹	Scale Factor (Reg #)	Factory Default	Min	Max	Access Level
Header:								
41628	U16	Model Identifier	n/a	n/a	712	n/a	n/a	R
41629	U16	Model Length - # of 16-bit registers to follow	n/a	n/a	60	n/a	n/a	R
Fixed Block:								
41630	U16	Watt-VAR Module Enable: 0 = Disable, 1 = Enable	ENUM	n/a	0	0	1	RW
41631	U16	Watt-VAR Adopt Curve Request	n/a	n/a	2	1	2	RW
41632	U16	Watt-VAR Adopt Curve Result: 0 = In Progress; 1 = Completed, 2 = Failed	ENUM	n/a	n/a	n/a	n/a	R
41633	U16	Watt-VAR Number of Curve Points Supported	n/a	n/a	10	n/a	n/a	R
41634	U16	Watt-VAR Number of Curves Supported	n/a	n/a	2	n/a	n/a	R
41640	S16	Watt-VAR Scale Factor - Active Power (%Wmax)	sunssf	n/a	-2	n/a	n/a	R
41641	S16	Watt-VAR Scale Factor - Reactive Power (%MAX)	sunssf	n/a	-2	n/a	n/a	R
Repeating Block #1:								
41642	U16	Watt-VAR Curve 1: Number of Active Points in Array	n/a	n/a	6	n/a	n/a	R
41643	U16	Watt-VAR Curve 1: VAR Dependent Reference: 0 = % Max Watts (REG 40266) 1 = % Max VARs (REG 40272) 2 = % Available VAR (<i>not supported, behaves like setting '1'</i>) 3 = % Max VA (REG 40271)	ENUM	n/a	1	n/a	n/a	R
41644	U16	Watt-VAR Curve 1: Power Priority: 0 = Active; 1 = Reactive	ENUM	n/a	1	n/a	n/a	R
41645	U16	Watt-VAR Curve 1: Read Only: 0 = Read/Write; 1 = Read Only	ENUM	n/a	1	n/a	n/a	R
41646	S16	Watt-VAR Curve 1: Point 1 - Watts (%W _{MAX} , REG 40266)	0.01%	41640	-10000	n/a	n/a	R
41647	S16	Watt-VAR Curve 1: Point 1 - VAR (%MAX, see REG 41643)	0.01%	41641	4400	n/a	n/a	R
41648	S16	Watt-VAR Curve 1: Point 2 - Watts (%W _{MAX} , REG 40266)	0.01%	41640	-5000	n/a	n/a	R
41649	S16	Watt-VAR Curve 1: Point 2 - VAR (%MAX, see REG 41643)	0.01%	41641	0	n/a	n/a	R
41650	S16	Watt-VAR Curve 1: Point 3 - Watts (%W _{MAX} , REG 40266)	0.01%	41640	-2000	n/a	n/a	R
41651	S16	Watt-VAR Curve 1: Point 3 - VAR (%MAX, see REG 41643)	0.01%	41641	0	n/a	n/a	R
41652	S16	Watt-VAR Curve 1: Point 4 - Watts (%W _{MAX} , REG 40266)	0.01%	41640	2000	n/a	n/a	R
41653	S16	Watt-VAR Curve 1: Point 4 - VAR (%MAX, see REG 41643)	0.01%	41641	0	n/a	n/a	R
41654	S16	Watt-VAR Curve 1: Point 5 - Watts (%W _{MAX} , REG 40266)	0.01%	41640	5000	n/a	n/a	R

Number	Data Type	Description	Units ¹	Scale Factor (Reg #)	Factory Default	Min	Max	Access Level
41655	S16	Watt-VAR Curve 1: Point 5 - VAR (%MAX, see REG 41643)	0.01%	41641	0	n/a	n/a	R
41656	S16	Watt-VAR Curve 1: Point 6 - Watts (%W _{MAX} , REG 40266)	0.01%	41640	10000	n/a	n/a	R
41657	S16	Watt-VAR Curve 1: Point 6 - VAR (%MAX, see REG 41643)	0.01%	41641	-4400	n/a	n/a	R
41658 - 41665	S16	Watt-VAR Curve 1: Points 7 thru 10 - Watts (%W _{MAX} , REG 40266)	0.01%	41640	10000	n/a	n/a	R
		Watt-VAR Curve 1: Points 7 thru 10 - VAR (%MAX, see REG 41643)	0.01%	41641	0	n/a	n/a	R
Repeating Block #2:								
41666	U16	Watt-VAR Curve 2: Number of Active Points in Array	n/a	n/a	Note ²	1	10	RW
41667	U16	Watt-VAR Curve 2: VAR Dependent Reference: 0 = % Max Watts (REG 40266) 1 = % Max VARs (REG 40272) 2 = % Available VAR (<i>not supported, behaves like setting '1'</i>) 3 = % Max VA (REG 40271)	ENUM	n/a	Note ²	0	3	RW
41668	U16	Watt-VAR Curve 2: Power Priority: 0 = Active; 1 = Reactive	ENUM	n/a	Note ²	0	1	RW
41669	U16	Watt-VAR Curve 2: Read Only: 0 = Read/Write; 1 = Read Only	ENUM	n/a	0	n/a	n/a	R
41670 - 41689	S16	Watt-VAR Curve 2: Points 1 thru 10 - Watts (%W _{MAX} , REG 40266)	0.01%	41640	Note ²	-10000	10000	RW
		Watt-VAR Curve 2: Points 1 thru 10 - VAR (%MAX, see REG 41667)	0.01%	41641	Note ²	-10000	10000	RW

¹ Units include applied scale factor register

² Curve 2 data defaults to the latest Curve 1 values at POR - see section 11.2 for details on how to manage curve settings

11.3.16 SunSpec Model 714 Registers – DER DC Measurement

Number	Data Type	Description	Units ¹	Scale Factor (Reg #)	Factory Default	Min	Max	Access Level
Header:								
41690	U16	Model Identifier	n/a	n/a	714	n/a	n/a	R
41691	U16	Model Length - # of 16-bit registers to follow	n/a	n/a	43	n/a	n/a	R
Fixed Block:								
41694	U16	DC Port Count	n/a	n/a	1	n/a	n/a	R
41695	S16	DC Current - Total of All Ports	0.1 A	n/a	n/a	n/a	n/a	R
41696	S16	DC Power - Total of All Ports	10 W	n/a	n/a	n/a	n/a	R

Number	Data Type	Description	Units ¹	Scale Factor (Reg #)	Factory Default	Min	Max	Access Level
41705	S16	Scale Factor - DC Current	sunssf	n/a	-1	n/a	n/a	R
41706	S16	Scale Factor - DC Voltage	sunssf	n/a	-1	n/a	n/a	R
41707	S16	Scale Factor - DC Power	sunssf	n/a	1	n/a	n/a	R
41709	S16	Scale Factor - DC Temperature	sunssf	n/a	0	n/a	n/a	R
41710	U16	DC Port 1: Type: 0 = PV 1 = Energy Storage 2 = Electric Vehicle 3 = Generic Injecting 4 = Generic Absorbing 5 = Generic Bidirectional 6 = DC to DC	ENUM	n/a	5	n/a	n/a	R
41720	S16	DC Port 1: Current	0.1 A	41705	n/a	n/a	n/a	R
41721	U16	DC Port 1: Voltage	0.1 V	41706	n/a	n/a	n/a	R
41722	S16	DC Port 1: Power	10 W	41707	n/a	n/a	n/a	R
41731	S16	DC Port 1: Temperature - Heat Sink	C	41709	n/a	n/a	n/a	R

¹ Units include applied scale factor register

11.3.17 SunSpec Model 715 Registers – DER Control

Number	Data Type	Description	Units	Scale Factor (Reg #)	Factory Default	Min	Max	Access Level
Header:								
41735	U16	Model Identifier	n/a	n/a	715	n/a	n/a	R
41736	U16	Model Length - # of 16-bit registers to follow	n/a	n/a	7	n/a	n/a	R
Fixed Block:								
41737	U16	Local/Remote Control: 0 = Remote; 1 = Local (<i>HMI – not supported</i>)	ENUM	n/a	0	n/a	n/a	R
41738	U32	PCS Heartbeat: This read-only register is incremented by '1' once per second by the PCS, resetting back to zero after reaching a value of 2,147,483,647 (0x7FFFFFFF).	n/a	n/a	n/a	n/a	n/a	R

Number	Data Type	Description	Units	Scale Factor (Reg #)	Factory Default	Min	Max	Access Level
41740	U32	Controller Heartbeat: The PCS expects this register to be written by the Host Controller at regular intervals with a value equal to the previous value plus '1' or reset back to '0' at any time. Failure to do so will result in a Fault condition (<i>Communication Error</i>). Checking for the incrementing heartbeat value is not enabled until the first write to this register occurs following a POR. See Section 7.2.6 for more details.	n/a	n/a	0	0	0xFFFFFFFF	RW
41742	U16	Fault Reset: 0 = No Action; 1 = Reset Faults	ENUM	n/a	0	0	1	RW
41743	U16	Set Operation: 0 = Stop the PCS (disconnect DC and AC contactors) 1 = Start the PCS (pre-charge and connect DC and AC contactors) 2 = Enter Standby Mode (stop processing power) 3 = Exit Standby Mode (start processing power)	ENUM	n/a	0	0	3	RW

11.3.18 Oztek Extension Model 64340 Registers – Control and Status

Number	Data Type	Description	Units	Scale Factor (Reg #)	Factory Default	Min	Max	Access Level
Header:								
41744	U16	Model Identifier	n/a	n/a	64340	n/a	n/a	R
41745	U16	Model Length - # of 16-bit registers to follow	n/a	n/a	65	n/a	n/a	R
Fixed Block:								

Number	Data Type	Description	Units	Scale Factor (Reg #)	Factory Default	Min	Max	Access Level
41746	U16	PCS Operating State: 0 = Initialize 9 = Offline 1 = Fault 10 = Active Ride Thru 2 = Calibrate 11 = Passive Ride Thru 3 = Disabled 12 = Online – Grid Form 4 = Charge Wait 13 = Power Down 5 = Charging 16 = Turn Off 6 = Standby 17 = Island Transfer Wait 7 = Turn-On Delay 18 = Service Disabled 8 = Online – Grid Tie All Others = <i>Reserved</i>	ENUM	n/a	n/a	n/a	n/a	R
41747	U16	PCS Control Mode: 0 = <i>Grid Tie</i> , 1 = <i>Grid Forming (Island operation)</i>	ENUM	n/a	0	0	1	RW
41748	U16	Maximum DC Charge Current	0.1 A	41800	750	0	750	RW
41749	U16	Maximum DC Discharge Current	0.1 A	41800	750	0	750	RW
41750	U16	Positive Sequence Grid Current	0.1 A _{pk}	41801	0	n/a	n/a	R
41751	U16	Negative Sequence Grid Current	0.1 A _{pk}	41801	0	n/a	n/a	R
41752	U16	Positive Sequence Grid Voltage	0.1 V _{pk}	41802	0	n/a	n/a	R
41753	U16	Negative Sequence Grid Voltage	0.1 V _{pk}	41802	0	n/a	n/a	R
41754	U16	Active Ride-through Status - Bit field indicating active grid disturbance events: Bit 0 = Low Voltage Bit 2 = Low Frequency Bit 1 = High Voltage Bit 3 = High Frequency	Bitfield	n/a	n/a	n/a	n/a	R
41755	U16	Resume Status – Bit field indicating why resume operation is pending: Bit 0 = AC Frequency Too High Bit 8 = AC Voltage Van Too High Bit 1 = AC Frequency Too Low Bit 9 = AC Voltage Vbn Too High Bit 2 = AC Voltage Vab Too High Bit 10 = AC Voltage Vcn Too High Bit 3 = AC Voltage Vbc Too High Bit 11 = AC Voltage Van Too Low Bit 4 = AC Voltage Vca Too High Bit 12 = AC Voltage Vbn Too Low Bit 5 = AC Voltage Vab Too Low Bit 13 = AC Voltage Vcn Too Low Bit 6 = AC Voltage Vbc Too Low Bit 14 = Resume Delay Active Bit 7 = AC Voltage Vca Too Low	BitField	n/a	n/a	n/a	n/a	R

Number	Data Type	Description	Units	Scale Factor (Reg #)	Factory Default	Min	Max	Access Level
41756	U32	PCS Warning Status: Bit 0 = High AC Current A Bit 1 = High AC Current B Bit 2 = High AC Current C Bit 3 = High DC Current Bit 4 = High Grid Voltage AB Bit 5 = High Grid Voltage BC Bit 6 = High Grid Voltage CA Bit 7 = High DC Voltage Bit 8 = Low DC Voltage Bit 9 = AC Current Limit Bit 10 = DC Power Limit Bit 11 = AC Power Limit Bit 12 = Grid OOT Bit 13 = Resume – Delay Bit 14 = Island Detected Bit 15 = PLL Not Locked Bit 16 = Temperature Warning Bit 17 = <i>Reserved</i> Bit 18 = <i>Reserved</i> Bit 19 = Fan Warning Bit 20 = <i>Reserved</i> Bit 21 = Limit Active Power Bit 22 = HVRT Active Override Bit 23 = TVS Error Bit 24 = Volt-VAR Active Bit 25 = Volt-Watt Active Bit 26 = Freq-Watt Active Bit 27 = Loss of Phase Bit 28 = Negative Seq Current Limit Bit 29 = Watt-VAR Active Bit 30 = <i>Reserved</i> Bit 31 = AC Current Overload	Bitfield	n/a	n/a	n/a	n/a	R
41758	U32	PCS Fault Status: Bit 0 = H/W Over Current A Bit 1 = H/W Over Current B Bit 2 = H/W Over Current C Bit 3 = RMS Over Current A Bit 4 = RMS Over Current B Bit 5 = RMS Over Current C Bit 6 = DC Over Current Bit 7 = Grid Over Voltage AB Bit 8 = Grid Over Voltage BC Bit 9 = Grid Over Voltage CA Bit 10 = H/W DC Over Voltage Bit 11 = DC Over Voltage Bit 12 = DC Under Voltage Bit 13 = Ride Thru - Low Voltage Bit 14 = Ride Thru - High Voltage Bit 15 = Ride Thru - Low Freq Bit 16 = Ride Thru - High Freq Bit 17 = Island Condition Bit 18 = <i>Reserved</i> Bit 19 = Temperature Fault Bit 20 = ESTOP Bit 21 = Communication Error Bit 22 = Power Down Error Bit 23 = Invalid User Config Bit 24 = Invalid Model Bit 25 = Factory Fault Bit 26 = Saturation Error A Bit 27 = Saturation Error B Bit 28 = Saturation Error C Bits 29-30 = <i>Reserved</i> Bit 31 = AC Current Overload Trip	Bitfield	n/a	n/a	n/a	n/a	R

Number	Data Type	Description	Units	Scale Factor (Reg #)	Factory Default	Min	Max	Access Level
41760	U32	Factory Fault Status: Bit 0 = H/W DC Over Current A - bot Bit 1 = H/W DC Over Current B - bot Bit 2 = H/W DC Over Current C - bot Bit 3 = H/W DC Over Current A - top Bit 4 = H/W DC Over Current B - top Bit 5 = H/W DC Over Current C - top Bit 6 = DC Over Current A Bit 7 = DC Over Current B Bit 8 = DC Over Current C Bit 9 = DC Current Imbalance A Bit 10 = DC Current Imbalance B Bit 11 = DC Current Imbalance C Bit 12 = H/W Link Over Voltage - top Bit 13 = H/W Link Over Voltage - bot Bit 14 = Link Over Voltage Bit 15 = Link Voltage Imbalance Bit 16 = Pre-charge Timeout Bit 17 = Bias Under Voltage Bit 18 = Contactor Interlock Bit 19 = DC/DC Comm Error Bit 20 = Datalog Error Bit 21 = Invalid Factory Config Bit 22 = Config EEPROM Error Bit 23 = Calibration Error Bits 24-31 = <i>Reserved</i>	Bitfield	n/a	n/a	n/a	n/a	R
41762	U32	User Configuration Error Status: Bit 0 = Invalid Baud Rate Bit 1 = LVRT Curve Error Bit 2 = HVRT Curve Error Bit 3 = LFRT Curve Error Bit 4 = HFRT Curve Error Bit 5 = Volt-VAR Curve Error Bit 6 = Volt-Watt Curve Error Bit 7 = Freq-Watt Controller Error Bit 8 = Watt-VAR Curve Error All Others = <i>Reserved</i>	Bitfield	n/a	n/a	n/a	n/a	R
41764	U32	Temperature Status: Bit 0 = DC HS Over Temp - A Bit 1 = DC HS Over Temp - B Bit 2 = DC HS Over Temp - C Bit 3 = DC HS Imbalance Bit 4 = DC IGBT Over Temp - A Bit 5 = DC IGBT Over Temp - B Bit 6 = DC IGBT Over Temp - C Bit 7 = AC HS Over Temp - A Bit 8 = AC HS Over Temp - B Bit 9 = AC HS Over Temp - C Bit 10 = AC HS Imbalance Bit 11 = AC IGBT Over Temp - A Bit 12 = AC IGBT Over Temp - B Bit 13 = AC IGBT Over Temp - C Bit 14 = Cabinet Over Temp Bit 17 = High DC HS Temp Warning Bit 18 = High DC HS Imbalance Warning Bit 19 = High DC IGBT Temp Warning Bit 20 = High AC HS Temp Warning Bit 21 = High AC HS Imbalance Warning Bit 22 = High AC IGBT Temp Warning Bit 23 = High Cabinet Temp Warning All Others = <i>Reserved</i>	Bitfield	n/a	n/a	n/a	n/a	R

Number	Data Type	Description	Units	Scale Factor (Reg #)	Factory Default	Min	Max	Access Level
41766	U16	Fan Status: Bit 0 = Fan 1 Not Spinning Bit 1 = Fan 2 Not Spinning Bit 2 = Fan 3 Not Spinning All Others = <i>Reserved</i>	ENUM	n/a	n/a	n/a	n/a	R
41767	U16	Register Operation Status - Updated after every register read or write: 0 = Operation completed successfully 1 = Illegal/unsupported register ID 2 = Write was attempted to a Read-Only register 3 = Read was attempted from a Write-Only register 4 = Write data is not within legal range 5 = Configuration memory hardware error 6 = Configuration memory CRC mismatch 7 = Invalid password provided for operation 8 = Operation not allowed when the PCS is ON	ENUM	n/a	n/a	n/a	n/a	R
41768	U16	Software P/N – Inverter Controller	n/a	n/a	n/a	n/a	n/a	R
41769	U16	Software P/N – DC/DC Controller	n/a	n/a	n/a	n/a	n/a	R
41770	U16	Software P/N – Bootloader	n/a	n/a	n/a	n/a	n/a	R
41771	U16	Software Revision – Inverter Controller	n/a	n/a	n/a	n/a	n/a	R
41772	U16	Software Revision – DC/DC Controller	n/a	n/a	n/a	n/a	n/a	R
41773	U16	Software Revision – Bootloader	n/a	n/a	n/a	n/a	n/a	R
41774	U16	FPGA Revision	n/a	n/a	n/a	n/a	n/a	R
41775	U16	User Configuration Revision: The user may use this register to assign a revision code, allowing them to manage their changes to the default product configuration.	n/a	n/a	0	0	0xFFFF	RW
41776	U16	Factory Configuration Revision	n/a	n/a	n/a	n/a	n/a	R
41777	U16	Master Configuration Revision	n/a	n/a	n/a	n/a	n/a	R
41778	U16	Configuration Reset – Set User Values to Factory Defaults	n/a	n/a	0	0	0xFFFF	RW
41779	U16	Controller Reboot Command: To prevent accidental writes to this register from causing a controller reboot, a key value of 0x5555 must be written to this register to force a reboot. Writing any other value will have no effect. This register will always read back a zero.	ENUM	n/a	0	0	0xFFFF	RW

Number	Data Type	Description	Units	Scale Factor (Reg #)	Factory Default	Min	Max	Access Level
41780	U16	Password - Used to Access Protected Registers	n/a	n/a	0	0	0xFFFF	RW
41784	U16	Turn-on Delay Time Remaining	sec	n/a	0	n/a	n/a	R
41800	S16	Scale Factor – Maximum DC Current	sunssf	n/a	-1	n/a	n/a	R
41801	S16	Scale Factor - Grid Current	sunssf	n/a	-1	n/a	n/a	R
41802	S16	Scale Factor - Grid Voltage	sunssf	n/a	-1	n/a	n/a	R

11.3.19 Oztek Extension Model 64341 Registers – Configuration

Number	Data Type	Description	Units ¹	Scale Factor (Reg #)	Factory Default	Min	Max	Access Level
Header:								
41811	U16	Model Identifier	n/a	n/a	64341	n/a	n/a	R
41812	U16	Model Length - # of 16-bit registers to follow	n/a	n/a	56	n/a	n/a	R
Fixed Block:								
41813	U16	PCS Control Mode Power-On Default: 0 = Grid Tie 1 = Grid Forming (island operation)	ENUM	n/a	0	0	1	RW
41814	U16	Maximum DC Charge Current - POR Default	0.1 A	41856	750	0	750	RW
41815	U16	Maximum DC Discharge Current - POR Default	0.1 A	41856	750	0	750	RW
41817	U16	Reactive Power Priority VAR Limit (% of $V_{A_{MAX}}$, REG 40271)	0.1 % $V_{A_{MAX}}$	41857	1000	0	1000	RWO
41818	U16	Nominal AC Frequency Setting	0.01 Hz	41853	6000	4500	6500	RWO
41819	U16	Default Grid High Voltage Threshold (% of V_{NOM} , REG 40278): If the HVRT module is disabled (REG 40753) then this register is used to define the immediate disconnect threshold.	0.1 %	41854	1100	1000	1200	RWO
41820	U16	Default Grid Low Voltage Threshold (% of V_{NOM} , REG 40278): If the LVRT module is disabled (REG 40520) then this register is used to define the immediate disconnect threshold.	0.1 %	41854	880	0	1000	RWO
41821	U16	Default Grid High Frequency Threshold: If the HFRT module is disabled (REG 41291) then this register is used to define the immediate disconnect threshold.	0.01 Hz	41855	6050	5000	9000	RWO

Number	Data Type	Description	Units ¹	Scale Factor (Reg #)	Factory Default	Min	Max	Access Level
41822	U16	Default Grid Low Frequency Threshold: If the LFRT module is disabled (REG 49086) then this register is used to define the immediate disconnect threshold.	0.01 Hz	41855	5850	3000	6000	RWO
41823	U16	Initial Turn-On Window: Random turn-on window used when transitioning from Standby to Online.	0.1 sec	41858	0	0	36000	RW
41824	U16	Initial Turn-On Ramp Time: Time to ramp from 0 to 100% of W_{MAX} (REG 40266) when turning on from Standby.	0.1 sec	41855	10	1	10000	RW
41825	U16	Auto-Resume Timeout: How long to wait in the Offline state for the grid to return to within tolerance and resume operation. If the timeout expires, the PCS will disable itself and transition to the Fault state. A value of 0 disables the auto-resume feature, the PCS will immediately disable itself and transition to the Fault state.	sec	41859	3600	0	65534	RW
41826	U16	Ride Through Recover Delay: When in the Ride Through Passive state, if the grid voltage/frequency return to within normal levels or a less stringent Active ride through region, the PCS will first wait for this delay time before turning back on and going to the Online – Grid Tie or Ride Through Active states.	ms	41860	100	0	65534	RW
41827	U16	Resume From Cessation Ramp Time: Time to ramp to the pre-disturbance power setpoints when turning on from the Ride Through Passive state.	ms	41860	300	100	10000	RW
41828	U16	Anti-Island Detector Mode Select: 1 = Keep Running on Island Detect 2 = Fault Off on Island Detect 3 = Go Offline on Island Detect and auto-resume when the grid returns	ENUM	n/a	2	1	3	RW
41829	U16	AC Connection Type: 0 = Three-Wire Interface 1 = Four-Wire Interface 2 = Isolated Three-Wire Interface (<i>Optional, see Note 2</i>)	ENUM	n/a	0	0	2	RWO
41830	U16	Grid-Tie Turn-Off Current Slew Rate	A_{rms}/s	n/a	100	1	3000	RW
41831	U16	Voltage Unbalance Control Enable: 0 = Disable, 1 = Enable	ENUM	n/a	0	0	1	RWO
41832	S16	Voltage Unbalance Control Gain Scale	n/a	n/a	0	12	-12	RW

Number	Data Type	Description	Units ¹	Scale Factor (Reg #)	Factory Default	Min	Max	Access Level
41833	U16	Voltage Unbalance Control Gain	A/V	41832	5	0	65535	RW
41834	S16	Voltage Unbalance Droop Gain Scale	n/a	n/a	-3	12	-12	RW
41835	U16	Voltage Unbalance Droop Gain	V/A	41834	125	0	65535	RW
41836	U16	Communications Heartbeat Timeout: See Section 7.2.6 for details.	sec	n/a	2	2	60	RW
41853	S16	Scale Factor – Nominal Frequency	sunssf	n/a	-2	n/a	n/a	R
41854	S16	Scale Factor – Default Grid Voltage Thresholds	sunssf	n/a	-1	n/a	n/a	R
41855	S16	Scale Factor – Default Grid Frequency Thresholds	sunssf	n/a	-2	n/a	n/a	R
41856	S16	Scale Factor – DC Maximum Currents	sunssf	n/a	-1	n/a	n/a	R
41857	S16	Scale Factor – Reactive Power Priority VAR Limit	sunssf	n/a	-1	n/a	n/a	R
41858	S16	Scale Factor – Resume Turn-On Times	sunssf	n/a	-1	n/a	n/a	R
41859	S16	Scale Factor – Resume Timeout	sunssf	n/a	0	n/a	n/a	R
41860	S16	Scale Factor – Ride-Through Recover Delay Time	sunssf	n/a	-3	n/a	n/a	R

¹ Units include applied scale factor register

² Setting *AC Connection Type* to “2” is not required for isolated three-wire operation. When this setting is selected, the PCS utilizes 3rd Harmonic Injection on the inverter’s output voltage, enabling the higher *Active Ride Through* V_{MAX} of 576 V_{RMS} instead of 535 V_{RMS} . When this mode is selected, an external isolation transformer must be provided, the voltages at the PCS’s AC terminals must be floating, and the NUETRAL terminals on the PCS(s) must be left unconnected. For applications that do not require the higher *Active Ride Through* V_{MAX} , or where 3rd Harmonic Injection is undesirable, set *AC Connection Type* to “0”. Contact Oztek technical support for further details.

11.3.20 Oztek Extension Model 64302 Registers – Alarms

Number	Data Type	Description	Units ¹	Scale Factor (Reg #)	Factory Default	Min	Max	Access Level
Header:								
41869	U16	Model Identifier	n/a	n/a	64302	n/a	n/a	R
41870	U16	Model Length - # of 16-bit registers to follow	n/a	n/a	62	n/a	n/a	R
Fixed Block:								
41871	U16	AC Over Current Fault Threshold	0.1 Arms	41921	550	0	550	RW
41872	U16	AC Over Current Warning Threshold	0.1 Arms	41921	520	0	540	RW
41873	U16	AC Over Current Warning Recover Delta	0.1 Arms	41921	25	10	100	RW

Number	Data Type	Description	Units ¹	Scale Factor (Reg #)	Factory Default	Min	Max	Access Level
41874	U16	AC Over Voltage Fault Threshold (line-to-line)	0.1 Vrms	41920	5900	0	5900	RW
41875	U16	AC Over Voltage Warning Threshold (line-to-line)	0.1 Vrms	41920	5760	0	5900	RW
41876	U16	AC Over Voltage Warning Recover Delta (line-to-line)	0.1 Vrms	41920	50	10	1000	RW
41877	U16	DC Under Voltage Fault Threshold	0.1 V	41922	3100	3100	8200	RW
41878	U16	DC Under Voltage Warning Threshold	0.1 V	41922	3300	3300	8200	RW
41879	U16	DC Under Voltage Warning Recover Delta	0.1 V	41922	50	10	1000	RW
41880	U16	DC Over Voltage Fault Threshold	0.1 V	41922	8400	0	8400	RW
41881	U16	DC Over Voltage Warning Threshold	0.1 V	41922	8300	0	8400	RW
41882	U16	DC Over Voltage Warning Recover Delta	0.1 V	41922	50	10	1000	RW
41883	U32	Alarm Output 1 - PCS Fault Mask The bit fields correspond to Register 41758 – PCS Fault Status . Setting a mask bitfield to “1” will cause that fault to drive the Alarm output. Setting multiple mask bits to “1” logically OR’s them together.	Bitfield	n/a	0xFFFF FFFF	0	0xFFFF FFFF	RW
41885	U32	Alarm Output 1 - PCS Warning Mask The bit fields correspond to Register 41756 – PCS Warning Status . Setting a mask bitfield to “1” will cause that warning to drive the Alarm output. Setting multiple mask bits to “1” logically OR’s them together.	Bitfield	n/a	0	0	0xFFFF FFFF	RW
41887	U32	Alarm Output 2 - PCS Fault Mask The bit fields correspond to Register 41758 – PCS Fault Status . Setting a mask bitfield to “1” will cause that fault to drive the Alarm output. Setting multiple mask bits to “1” logically OR’s them together.	Bitfield	n/a	0	0	0xFFFF FFFF	RW
41889	U32	Alarm Output 2 - PCS Warning Mask The bit fields correspond to Register 41756 – PCS Warning Status . Setting a mask bitfield to “1” will cause that warning to drive the Alarm output. Setting multiple mask bits to “1” logically OR’s them together.	Bitfield	n/a	0xFFFF FFFF	0	0xFFFF FFFF	RW
41891	U16	Alarm Output Pin Polarity: Bit 0: Alarm Output 1 Polarity Value 0 = High-Z when status is True Value 1 = Drive output low when status is True Bit 1: Alarm output 2 Polarity Value 0 = High-Z when status is True Value 1 = Drive output low when status is True	ENUM	n/a	0	0	3	RW

Number	Data Type	Description	Units ¹	Scale Factor (Reg #)	Factory Default	Min	Max	Access Level
41892	U32	<p>Alarm Output 1 - PCS State Mask: Setting the mask bitfield to "1" will cause the Alarm output to be asserted while the PCS is in that operating state. Setting multiple mask bits to "1" logically OR's them together.</p> <p>Bit 0 = Initialize Bit 1 = Fault Bit 2 = Calibrate Bit 3 = Disabled Bit 4 = Charge Wait Bit 5 = Charging Bit 6 = Standby Bit 7 = Turn-On Delay Bit 8 = Online – Grid Tie</p> <p>Bit 9 = Offline Bit 10 = Active Ride Thru Bit 11 = Passive Ride Thru Bit 12 = Online – Grid Form Bit 13 = Power Down Bit 16 = Turn Off Bit 17 = Island Transfer Wait Bit 18 = Service Disabled All Others = <i>Reserved</i></p>	Bitfield	n/a	0	0	0xFFFF FFFF	RW
41894	U32	<p>Alarm Output 2 - PCS State Mask: Setting the mask bitfield to "1" will cause the Alarm output to be asserted while the PCS is in that operating state. Setting multiple mask bits to "1" logically OR's them together.</p> <p>Bit 0 = Initialize Bit 1 = Fault Bit 2 = Calibrate Bit 3 = Disabled Bit 4 = Charge Wait Bit 5 = Charging Bit 6 = Standby Bit 7 = Turn-On Delay Bit 8 = Online – Grid Tie</p> <p>Bit 9 = Offline Bit 10 = Active Ride Thru Bit 11 = Passive Ride Thru Bit 12 = Online – Grid Form Bit 13 = Power Down Bit 16 = Turn Off Bit 17 = Island Transfer Wait Bit 18 = Service Disabled All Others = <i>Reserved</i></p>	Bitfield	n/a	0	0	0xFFFF FFFF	RW
41896	U16	<p>Alarm Output 1 – Function Mask: Setting the mask bitfield to "1" will cause the Alarm output to be asserted when the selected function/action is active. Setting multiple mask bits to "1" logically OR's them together.</p> <p>Bit 0 = Inverter PWM Outputs Enabled Bits 1-15 = <i>Reserved</i></p>	Bitfield	n/a	0	0	0xFFFF	RW

Number	Data Type	Description	Units ¹	Scale Factor (Reg #)	Factory Default	Min	Max	Access Level
41897	U16	Alarm Output 2 – Function Mask: Setting the mask bitfield to “1” will cause the Alarm output to be asserted when the selected function/action is active. Setting multiple mask bits to “1” logically OR’s them together. Bit 0 = Inverter PWM Outputs Enabled Bits 1-15 = <i>Reserved</i>	Bitfield	n/a	0	0	0xFFFF	RW
41898	U16	DC Over Current Fault Threshold	0.1 A	41923	950	0	950	RW
41899	U16	DC Over Current Warning Threshold	0.1 A	41923	800	0	950	RW
41900	U16	DC Over Current Warning Recover Delta	0.1 A	41923	25	10	100	RW
41901	U32	Alarm Output 1 – DER Alarm Bit Mask The bit fields correspond to Register 40091 – DER Alarm Bitfield . Setting a mask bitfield to “1” will cause that fault to drive the Alarm output. Setting multiple mask bits to “1” logically OR’s them together.	Bitfield	n/a	0	0	0xFFFF FFFF	RW
41903	U32	Alarm Output 2 – DER Alarm Bit Mask The bit fields correspond to Register 40091 – DER Alarm Bitfield . Setting a mask bitfield to “1” will cause that fault to drive the Alarm output. Setting multiple mask bits to “1” logically OR’s them together.	Bitfield	n/a	0x0000 0F1C	0	0xFFFF FFFF	RW
41920	S16	Scale Factor – AC Voltage	sunssf	n/a	-1	n/a	n/a	R
41921	S16	Scale Factor – AC Current	sunssf	n/a	-1	n/a	n/a	R
41922	S16	Scale Factor – DC Voltage	sunssf	n/a	-1	n/a	n/a	R
41923	S16	Scale Factor – DC Current	sunssf	n/a	-1	n/a	n/a	R

¹ Units include applied scale factor register

11.3.21 Oztek Extension Model 64304 Registers – Firmware Update

Number	Data Type	Description	Units	Scale Factor (Reg #)	Factory Default	Min	Max	Access Level
Header:								
41933	U16	Model Identifier	n/a	n/a	64304	n/a	n/a	R
41934	U16	Model Length - # of 16-bit registers to follow	n/a	n/a	148	n/a	n/a	R

Number	Data Type	Description	Units	Scale Factor (Reg #)	Factory Default	Min	Max	Access Level
Fixed Block:								
41935	U16	Jump to Bootloader Command: 0 = No Action; 1 = Jump to bootloader	ENUM	n/a	0	0	1	RWO
41936	U16	Firmware Update – Data Transmission Object, Word 0 (DTO_WRD0) MSB = Return Code; LSB = Packet ID	n/a	n/a	0	n/a	n/a	R
41937	U16	Firmware Update – Data Transmission Object, Word 1 (DTO_WRD1) MSB = Data Byte 0; LSB = Count	n/a	n/a	0	n/a	n/a	R
41938	U16	Firmware Update – Data Transmission Object, Word 2 (DTO_WRD2) MSB = Data Byte 2; LSB = Data Byte 1	n/a	n/a	0	n/a	n/a	R
41939	U16	Firmware Update – Data Transmission Object, Word 3 (DTO_WRD3) MSB = Data Byte 4; LSB = Data Byte 3	n/a	n/a	0	n/a	n/a	R
41940	U16	Firmware Update – Control Receive Object, Word 0 (CRO_WRD0) MSB = Count; LSB = Command	n/a	n/a	0	0	65535	RW
41941	U16	Firmware Update – Control Receive Object, Word 1 (CRO_WRD1) MSB = Data Byte 1; LSB = Data Byte 0	n/a	n/a	0	0	65535	RW
41942	U16	Firmware Update – Control Receive Object, Word 2 (CRO_WRD2) MSB = Data Byte 3; LSB = Data Byte 2	n/a	n/a	0	0	65535	RW
41943 - 42065	U16	CRO_WRD3 ... CRO_WRD125	n/a	n/a	0	0	65535	RW
42066	U16	Firmware Update – Control Receive Object, Word 126 (CRO_WRD126) MSB = Data Byte 251; LSB = Data Byte 250	n/a	n/a	0	0	65535	RW

11.3.22 Oztek Extension Model 64305 Registers – Datalogging

Number	Data Type	Description	Units	Scale Factor (Reg #)	Factory Default	Min	Max	Access Level
Header:								
42083	U16	Model Identifier	n/a	n/a	64305	n/a	n/a	R
42084	U16	Model Length - # of 16-bit registers to follow	n/a	n/a	126	n/a	n/a	R
Fixed Block:								

Number	Data Type	Description	Units	Scale Factor (Reg #)	Factory Default	Min	Max	Access Level
42085	U32	<p>Real Time Clock – Set Date</p> <p>This register is used to set the date using the following format:</p> <p>BITS [13..0] = Year BITS [15..14] = not used BITS [23..16] = Month BITS [31..21] = Day</p> <p>Example: 3/21/2017 would be 0x150307E1</p> <p>NOTE: <i>For synchronization purposes, the Date is internally latched upon writing the Set Time Register, 42087. If the user fails to write to register 42087, the date will NOT be set. To correctly set the date and time, the user should write to register 42085, followed by a write to 42087.</i></p>	ENUM	n/a	0	0	0x1FOC FFFF	RW
42087	U32	<p>Real Time Clock – Set Time</p> <p>This register is used to set the time using the following format:</p> <p>BITS [7..0] = Hours BITS [15..8] = Minutes BITS [23..16] = Seconds BITS [31..24] = not used</p> <p>Example: 1:48pm would be 0x0000300D</p> <p>NOTE: <i>For synchronization purposes, writing to this register also latches the data written to register 42085. To correctly set the date and time, the user should write to register 42085, followed by a write to 42087.</i></p>	ENUM	n/a	0	0	0x003B 3B17	RW
42089	U32	<p>Real Time Clock – Get Date</p> <p>Returns the Date in the following format:</p> <p>BITS [13..0] = Year BITS [14] = Set Status: 0 = Date has not been set since POR 1 = Date has been set since POR</p> <p>BITS [15] = not used BITS [23..16] = Month BITS [31..21] = Day</p>	ENUM	n/a	n/a	n/a	n/a	R

Number	Data Type	Description	Units	Scale Factor (Reg #)	Factory Default	Min	Max	Access Level
42091	U32	Real Time Clock – Get Time Returns the Time in the following format: BITS [7..0] = Hours BITS [15..8] = Minutes BITS [23..16] = Seconds BITS [30..24] = not used BITS [31] = Set Status: 0 = Time has not been set since POR 1 = Time has been set since POR NOTE: For synchronization purposes, the Time data is internally latched when register 42089 is read. To correctly read the time, the user must first read register 42089, followed by a read to 42091.	ENUM	n/a	n/a	n/a	n/a	R
42093	U16	Fault Log Sample Period	ms	n/a	1	n/a	n/a	R
42094	U16	Fault Log Number of Available Logs: Returns the number of logs containing valid data.	n/a	n/a	n/a	0	12	R
42095	U16	Reserved Factory Command Register	ENUM	n/a	n/a	n/a	n/a	R
42096	U16	Reserved Factory Status Register	ENUM	n/a	n/a	n/a	n/a	R
42097	U16	Fault Log Select: Used to select a log from which to read header and/or data from.	n/a	n/a	0	0	11	RW
42098	U16	Fault Log Get Header: 0 = No Action; 1 = Fetch Data Get the header for the log selected in register 42097 . Header data will be placed in the Data Log Read Buffer registers starting at 42132 . See section 9.1.1 for details on the header information.	ENUM	n/a	0	0	1	RW
42099	U16	Fault Log Get Selected Record: Writing the desired sample record # to this register will load that data from the log specified by register 42097 into the Data Log Read Buffer registers starting at 42132 .	n/a	n/a	0	0	0xFFFF	RW
42100	U16	Reserved Factory Command Register	ENUM	n/a	n/a	n/a	n/a	R
42101	U16	User Log Start/Stop: Used to start the data logger and arm the trigger: 0 = Stop 1 = Start	ENUM	n/a	0	0	1	RW
42102	U16	User Log Post Trigger Percentage: Defines how much of the buffer is used for storing post trigger data.	%	n/a	0	0	100	RW

Number	Data Type	Description	Units	Scale Factor (Reg #)	Factory Default	Min	Max	Access Level
42103	U16	User Log Sample Period: Sets the time between samples for the User Log. See section 9.1.2.2 for details on selecting the sample period.	ms	n/a	10	1	30000	RW
42104	U32	User Log Variable Selection (LSW) See section 9.1.2.1 for details.	n/a	n/a	1	0	0xFFFF FFFF	RW
42106	U32	User Log Variable Selection (MSW) See section 9.1.2.1 for details.	n/a	n/a	0	0	0xFFFF FFFF	RW
42108	U16	User Log Trigger Mode: See section 9.1.2.3 for details. 0 = Continuous 1 = Single 2 = Dual OR 3 = Dual AND	ENUM	n/a	0	0	3	RW
42109	U16	User Log Trigger 1 Compare Type: See section 9.1.2.4 for details. 0 = Less Than 1 = Greater Than 2 = Equal To 3 = Not Equal To	ENUM	n/a	0	0	3	RW
42110	U16	User Log Trigger 1 Variable Selection See section 9.1.2.4 for details.	n/a	n/a	0	0	63	RW
42111	U32	User Log Trigger 1 Value Mask See section 9.1.2.4 for details.	n/a	n/a	0	0	0xFFFF FFFF	RW
42113	U32	User Log Trigger 1 Value See section 9.1.2.4 for details.	n/a	n/a	0	0	0xFFFF FFFF	RW
42115	U16	User Log Trigger 2 Compare Type: See section 9.1.2.4 for details. 0 = Less Than 1 = Greater Than 2 = Equal To 3 = Not Equal To	ENUM	n/a	0	0	3	RW
42116	U16	User Log Trigger 2 Variable Selection See section 9.1.2.4 for details.	n/a	n/a	0	0	63	RW

Number	Data Type	Description	Units	Scale Factor (Reg #)	Factory Default	Min	Max	Access Level
42117	U16	User Log Trigger 2 Value Mask See section 9.1.2.4 for details.	n/a	n/a	0	0	0xFFFF FFFF	RW
42119	U32	User Log Trigger 2 Value See section 9.1.2.4 for details.	n/a	n/a	0	0	0xFFFF FFFF	RW
42121	U16	User Log Status: 0 = Idle 1 = Capturing (no Trigger) 2 = Capturing (Triggered) 3 = Finished	ENUM	n/a	n/a	n/a	n/a	R
42122	U16	User Log Get Header: 0 = No Action; 1 = Fetch Data Get the header for the User Log. Header data will be placed in the Data Log Read Buffer registers starting at 42132 . See section 9.1.2.5 for details on the header information.	ENUM	n/a	0	0	1	RW
42123	U16	User Log Get Selected Sample Data: Writing the desired sample record # to this register will load that data from the User log into the Data Log Read Buffer registers starting at 42132 .	n/a	n/a	0	0	0xFFFF	RW
42124	U16	Fault History Log Set Fault Index: Selects a fault event from either register 41758 PCS Fault Status or 41760 Factory Fault Status for which to read the fault time stamps as follows: 0 = 41758 PCS Fault Status Bit 0 ... 31 = 41758 PCS Fault Status Bit 31 32 = 41760 Factory Fault Status Bit 0 ... 63 = 41760 Factory Fault Status Bit 31	ENUM	n/a	0	0	63	RW
42125	U16	Fault History Log Number of Entries for Specified Fault: Returns the # of fault events that have been stored for the fault specified by register 42124 .	n/a	n/a	n/a	n/a	n/a	R
42126	U16	Fault History Log Get History Data for Specified Fault: 0 = NOP; 1 = Fetch Data Writing a "1" will load the history data for the fault specified by register 42124 into the Data Log Read Buffer registers starting at 42132 .	ENUM	n/a	0	0	1	RW
42127	U16	Reserved Factory Command Register	ENUM	n/a	n/a	n/a	n/a	R

Number	Data Type	Description	Units	Scale Factor (Reg #)	Factory Default	Min	Max	Access Level
42128	U16	Operation Log Read Timer Variables: See section 9.3.1 for additional details. MSB = # of variables to be read; LSB = Variable Index	ENUM	n/a	0	0	0xFFFF	RW
42129	U16	Operation Log Read Fault Counts: See section 9.2.1 for additional details. MSB = # of counters to be read; LSB = Counter Index	ENUM	n/a	0	0	0xFFFF	RW
42130	U16	Operation Log Read Min/Max Values: See section 9.3.2 for additional details. MSB = # of variables to be read; LSB = Variable Index	ENUM	n/a	0	0	0xFFFF	RW
42131	U16	Reserved Factory Command	ENUM	n/a	n/a	n/a	n/a	R
42132-42200	U32	Datalog – Read Buffer (35 x 32-bit words, or 70 x 16-bit words)	n/a	n/a	n/a	n/a	n/a	R

11.3.23 Oztek Extension Model 64308 Registers – Grid Forming Configuration & Control

Number	Data Type	Description	Units ⁴	Scale Factor (Reg #)	Factory Default	Min	Max	Access Level
Header:								
42211	U16	Model Identifier	n/a	n/a	64308	n/a	n/a	R
42212	U16	Model Length - # of 16-bit registers to follow	n/a	n/a	58	n/a	n/a	R
Fixed Block:								
42213	U16	Grid Form Voltage Command (line-to-line)	0.1 Vrms	42254	n/a ²	n/a ¹	n/a ¹	RW
42214	U16	Grid Form Frequency Command	0.01 Hz	42255	n/a ³	n/a ¹	n/a ¹	RW
42215	S16	Grid Form Active Power Offset Command	0.1 %W _{MAX}	42256	0	-1000	1000	RW
42216	S16	Grid Form Reactive Power Offset Command	0.1 %VAR _{MAX}	42256	0	-1000	1000	RW
42217	U16	Grid Form Voltage Command Maximum	0.1 Vrms	42254	5080	3360	5280	RW
42218	U16	Grid Form Voltage Command Minimum	0.1 Vrms	42254	4160	0	5280	RW
42219	U16	Grid Form Voltage Command Slew Rate	Vrms/s	42257	480	1	28800	RW
42220	U16	Grid Form Frequency Command Maximum	0.01 Hz	42255	6500	4500	6500	RW
42221	U16	Grid Form Frequency Command Minimum	0.01 Hz	42255	4500	4500	6500	RW

Number	Data Type	Description	Units ⁴	Scale Factor (Reg #)	Factory Default	Min	Max	Access Level
42222	U16	Grid Form Frequency Command Slew Rate	0.01 Hz/s	42258	10	1	1000	RW
42223	S16	Grid Form Active Power Offset Turn-On Default	0.1 %W _{MAX}	42256	0	-1000	1000	RW
42224	S16	Grid Form Active Power Offset Maximum	0.1 %W _{MAX}	42256	1000	-1000	1000	RW
42225	S16	Grid Form Active Power Offset Minimum	0.1 %W _{MAX}	42256	-1000	-1000	1000	RW
42226	S16	Grid Form Reactive Power Offset Turn-On Default	0.1 %VAR _{MAX}	42256	0	-1000	1000	RW
42227	S16	Grid Form Reactive Power Offset Maximum	0.1 %VAR _{MAX}	42256	1000	-1000	1000	RW
42228	S16	Grid Form Reactive Power Offset Minimum	0.1 %VAR _{MAX}	42256	-1000	-1000	1000	RW
42229	U16	Grid Form Power Offset Slew Rate	0.1 %W _{MAX} /s	42259	1000	1	10000	RW
42230	U16	Grid Form Startup Voltage Slew Rate	V _{rms} /s	42257	4800	1	28800	RW
42231	U16	Island Control Input Pin Configuration: 0 = Disabled 1 = Passive Transfer – active high for Island Mode 2 = Passive Transfer – active low for Island Mode 3 = Seamless Transfer – active high for Island Mode 4 = Seamless Transfer – active low for Island Mode	ENUM	n/a	0	0	4	RWO
42232	U16	Grid Form Maximum Operating Voltage	0.1 %V _{NOM}	42260	1100	1000	1200	RW
42233	U16	Grid Form Minimum Operating Voltage	0.1 %V _{NOM}	42260	700	0	1000	RW
42234	U16	Grid Form Maximum Operating Frequency	0.01 Hz	42261	6200	5000	9000	RW
42235	U16	Grid Form Minimum Operating Frequency	0.01 Hz	42261	5800	3000	6000	RW
42236	S16	Grid Form Droop V/Q Proportional Gain Scale	n/a	n/a	-7	-12	12	RW
42237	U16	Grid Form Droop V/Q Proportional Gain	V _{rms} /VAR	42236	2500	0	65535	RW
42238	S16	Grid Form Droop W/P Proportional Gain Scale	n/a	n/a	-7	-12	12	RW
42239	U16	Grid Form Droop W/P Proportional Gain	Hz/W	42238	50	0	65535	RW
42240	S32	Grid Form Virtual Inductance	nH	42262	600000	-1x10 ⁹	1x10 ⁹	RW
42242	S32	Grid Form Virtual Resistance	uOhm	42263	250000	-1x10 ⁹	1x10 ⁹	RW
42244	U16	Grid Form Max Reconnect Voltage	0.1 %V _{NOM}	42260	1059	1000	1100	RW
42245	U16	Grid Form Min Reconnect Voltage	0.1 %V _{NOM}	42260	867	0	1000	RW
42246	U16	Grid Form Max Reconnect Frequency	0.01 Hz	42261	6100	4500	6500	RW
42247	U16	Grid Form Min Reconnect Frequency	0.01 Hz	42261	5900	4500	6500	RW
42248	U16	Island Control Input - Grid Tie to Island Debounce & Delay	ms	42264	30	1	1000	RW
42249	U16	Island Control Input - Island to Grid Tie Debounce & Delay	ms	42264	40	1	1000	RW
42250	U16	Seamless Transfer Offline Timeout Delay	ms	42264	200	0	300	RW

Number	Data Type	Description	Units ⁴	Scale Factor (Reg #)	Factory Default	Min	Max	Access Level
42251	U16	Seamless Transfer to Island Voltage Ramp Up Delay	ms	42264	20	0	1000	RW
42254	S16	Scale Factor – Grid Form Voltage Command	sunssf	n/a	-1	n/a	n/a	R
42255	S16	Scale Factor – Grid Form Frequency Command	sunssf	n/a	-2	n/a	n/a	R
42256	S16	Scale Factor – Grid Form Power Command	sunssf	n/a	-1	n/a	n/a	R
42257	S16	Scale Factor – Grid Form Voltage Slew	sunssf	n/a	0	n/a	n/a	R
42258	S16	Scale Factor – Grid Form Frequency Slew	sunssf	n/a	-2	n/a	n/a	R
42259	S16	Scale Factor – Grid Form Power Slew	sunssf	n/a	-1	n/a	n/a	R
42260	S16	Scale Factor – Grid Form Voltage Limits	sunssf	n/a	-1	n/a	n/a	R
42261	S16	Scale Factor – Grid Form Frequency Limits	sunssf	n/a	-2	n/a	n/a	R
42262	S16	Scale Factor – Grid Form Virtual Inductance	sunssf	n/a	-9	n/a	n/a	R
42263	S16	Scale Factor – Grid Form Virtual Resistance	sunssf	n/a	-6	n/a	n/a	R
42264	S16	Scale Factor – Mode Change Delays	sunssf	n/a	-3	n/a	n/a	R

¹ These min/max values are set by their corresponding command min/max configuration registers

² Initialized to **REG 40278 – Nominal AC Voltage Setting (V_{NOM})** at POR and each time **PCS Mode** is changed from Grid Tie to Grid Forming

³ Initialized to **REG 41818 – Nominal AC Frequency Setting** at POR and each time **PCS Mode** is changed from Grid Tie to Grid Forming

⁴ Units include applied scale factor registers

11.3.24 SunSpec Model 0xFFFF Registers – End Model

Number	Data Type	Description	Units	Scale Factor (Reg #)	Factory Default	Min	Max	Access Level
Header:								
42271	U16	Model Identifier	n/a	n/a	0xFFFF	n/a	n/a	R
42272	U16	Model Length - # of 16-bit registers to follow	n/a	n/a	0	n/a	n/a	R

12. Servicing the Unit

The PCS is not field serviceable. If the unit needs to return to the manufacturer for evaluation and possible repair, consult the Return Material Authorization Policy of this document as to how to proceed. In removing the PCS from system installation, consult and follow the General Safety precautions of Section 1.3.

13. Maintenance and Upgrade

Electrical connections should be regularly checked for mechanical integrity and thermal degradation. Airflow must be maintained and unobstructed for maximum performance.

13.1 Firmware Updates



CAUTION

When performing PCS firmware updates, the software may automatically reset the values of the configuration registers back to their factory default values. The user must take care to save a copy of any custom settings prior to performing the firmware update.

It is important that the PCS remain powered for up to 5 seconds following a firmware upgrade. This allows time for the application firmware to complete the configuration update. Removing bias power before the update is complete can corrupt the non-volatile, configuration memory.

The PCS supports in-system firmware updates. The Oztek-provided Power Studio™ Tool can be used to perform the update, or alternatively, the customer can incorporate the update functionality into their system controller. The firmware update register set is defined in Section 11.3.21.

To begin the update process, the system controller must first write a 1 to **REG 41935 – Jump to Bootloader Command**. This causes the PCS to load and execute the bootloader image, after which the PCS will only respond to read/writes of **REG 41936** through **REG 42066**. Once the update is complete, the bootloader provides a command to resume execution of the PCS application. Please consult FS-0057 – TMS28x CAN Bootloader Functional Specification for details on how to use these registers to update the application image.

The 4 LED status indicators on the front panel are used to provide Bootloader status and progress information. Table 6 defines each LEDs meaning when the bootloader is running.

**CAUTION**

The Modbus Addresses provided in the Modbus Register Map table in FS-0057 should be replaced with the corresponding register addresses, 41936 through 42066, in section 11.3.21 Oztek Extension Model 64304 Registers – Firmware Update.

14. Oztek Power Studio™ Tool

The Oztek Power Studio™ tool is a Microsoft Windows based Graphical User Interface (GUI), as shown in Figure 33, which can be used to easily configure and control the PCS. The tool communicates with the unit using Modbus and provides a simple, intuitive user interface. Some of the features provided by Power Studio™ include:

- Simple tabbed interfaces:
 - Dashboard
 - Instrumentation
 - Register Map
 - Software Upgrade
 - Datalogging
- Dashboard for PCS control and monitoring
- Multi-Target Support
- PCS configuration control, including:
 - Editing configurations
 - Downloading/uploading configurations
 - Archiving multiple configuration files

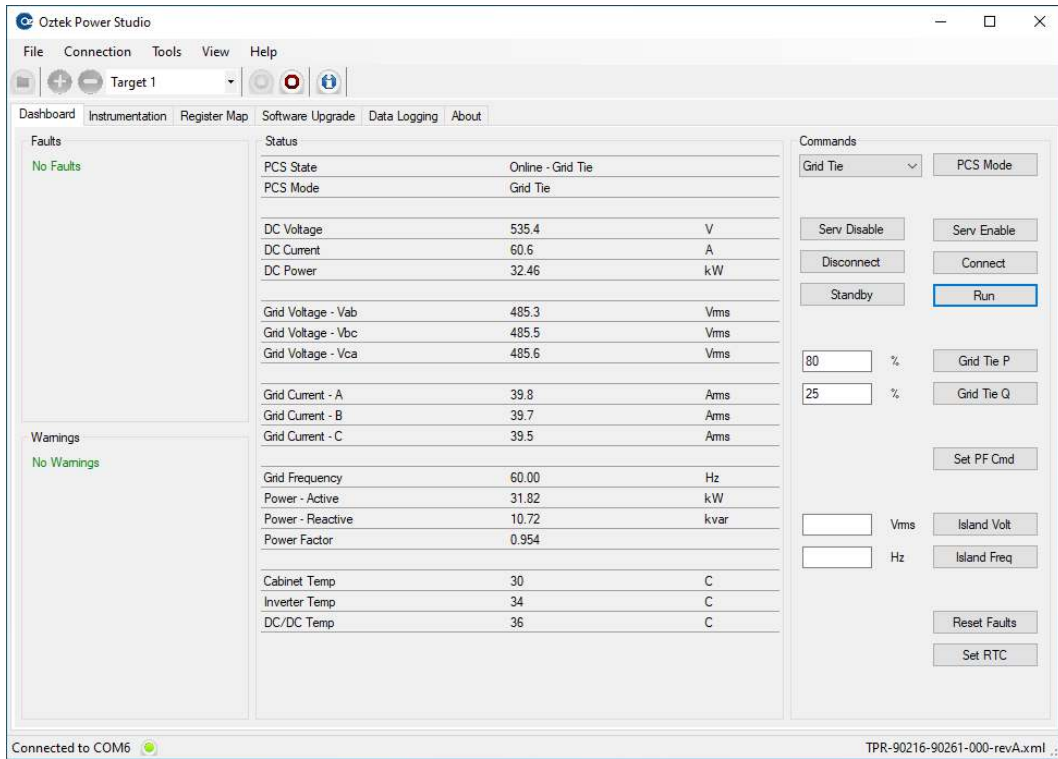

Figure 33 - Oztek Power Studio™ GUI

For detailed information and operating instructions, please refer to UM-0052 Oztek Power Studio™ User's Manual.

15. Appendix A – Records of Certification



AUTHORIZATION TO MARK

This authorizes the application of the Certification Mark(s) shown below to the models described in the Product(s) Covered section when made in accordance with the conditions set forth in the Certification Agreement and Listing Report. This authorization also applies to multiple listee model(s) identified on the correlation page of the Listing Report.

This document is the property of Intertek Testing Services and is not transferable. The certification mark(s) may be applied only at the location of the Party Authorized To Apply Mark.

Applicant: Trystar, LLC	Manufacturer: Trystar, LLC
Address: 11 Continental Blvd Merrimack, NH 03054	Address: 11 Continental Blvd Merrimack, NH 03054
Country: USA	Country: USA
Party Authorized To Apply Mark: Same as Manufacturer	
Report Issuing Office: Intertek Testing Services NA, Inc., Cortland, NY	
Control Number: <u>5014987</u>	Authorized by: <u><i>John H. ...</i></u> for L. Matthew Snyder, Certification Manager



This document supersedes all previous Authorizations to Mark for the noted Report Number.

This Authorization to Mark is for the exclusive use of Intertek's Client and is provided pursuant to the Certification agreement between Intertek and its Client. Intertek's responsibility and liability are limited to the terms and conditions of the agreement. Intertek assumes no liability to any party, other than to the Client in accordance with the agreement, for any loss, expense or damage occasioned by the use of this Authorization to Mark. Only the Client is authorized to permit copying or distribution of this Authorization to Mark and then only in its entirety. Use of Intertek's Certification mark is restricted to the conditions laid out in the agreement and in this Authorization to Mark. Any further use of the Intertek name for the sale or advertisement of the tested material, product or service must first be approved in writing by Intertek. Initial Factory Assessments and Follow up Services are for the purpose of assuring appropriate usage of the Certification mark in accordance with the agreement, they are not for the purposes of production quality control and do not relieve the Client of their obligations in this respect.

Intertek Testing Services NA Inc.
545 East Algonquin Road, Arlington Heights, IL 60005
Telephone 800-345-3851 or 847-439-5867 Fax 312-283-1672

Standard(s):	Inverters, Converters, Controllers and Interconnection System Equipment for use with Distributed Energy Resources [UL 1741:2021 Ed.3] Grid Support Utility Interactive Inverters and Converters Based Upon IEEE 1547:2018 & IEEE 1547.1:2020 - Supplement SB to UL 1741:2021 Ed.3 - Inverters, Converters, Controllers and Interconnection System Equipment for use with Distributed Energy Resources [UL 1741:2021 Ed.3 (Supplement SB)] Power Conversion Equipment [CSA C22.2#107.1:2016 Ed.4]
Product:	Energy Storage Power Conversion System
Brand Name:	OZTEK, TRYSTAR
Models:	OZPCS-RS40 may be followed by -PS; followed by -F or -B; followed by two characters.



THE SUNSPEC ALLIANCE HEREBY CERTIFIES THAT
Oztek Corp.

PRODUCT NAME
OZFCS Power Conversion System

CATEGORY
Inverter

PRODUCT MODELS
OZPCS-RS40
OZPCS-EP40

**Has been issued this
SunSpec Certified Product Award for
Successful Testing and Certification of the**

SUNSPEC INFORMATION MODELS

1	707
17	708
701	709
702	710
703	711
704	712
705	714
706	715

AWARDED ON
5/1/2023

CERTIFICATE NUMBER
SM-000027



Tom Tansy, Chairman



Warranty and Product Information

Limited Warranty

What does this warranty cover and how long does it last? This Limited Warranty is provided by Oztek Corp. ("Oztek") and covers defects in workmanship and materials in your PCS. This Warranty Period lasts for 5 years from the date of purchase at the point of sale to you, the original end user customer, unless otherwise agreed in writing. You will be required to demonstrate proof of purchase to make warranty claims. This Limited Warranty is transferable to subsequent owners but only for the unexpired portion of the Warranty Period. Subsequent owners also require original proof of purchase as described in "What proof of purchase is required?" An extended warranty is available for purchase; contact Oztek Sales for details.

What will Oztek do? During the Warranty Period Oztek will, at its option, repair the product (if economically feasible) or replace the defective product free of charge, provided you notify Oztek of the product defect within the Warranty Period, and provided that through inspection Oztek establishes the existence of such a defect and that it is covered by this Limited Warranty.

Oztek will, at its option, use new and/or reconditioned parts in performing warranty repair and building replacement products. Oztek reserves the right to use parts or products of original or improved design in the repair or replacement. If Oztek repairs or replaces a product, its warranty continues for the remaining portion of the original Warranty Period or 90 days from the date of the return shipment to the customer, whichever is greater. All replaced products and all parts removed from repaired products become the property of Oztek.

Oztek covers both parts and labor necessary to repair the product, and return shipment to the customer via an Oztek-selected non-expedited surface freight within the contiguous United States and Canada. Alaska, Hawaii and locations outside of the United States and Canada are excluded. Contact Oztek Customer Service for details on freight policy for return shipments from excluded areas.

How do you get service? If your product requires troubleshooting or warranty service, contact your merchant. If you are unable to contact your merchant, or the merchant is unable to provide service, contact Oztek directly at:

USA
Telephone: 603-546-0090
Email techsupport@oztekcorp.com

Direct returns may be performed according to the Oztek Return Material Authorization Policy described in your product manual.

What proof of purchase is required? In any warranty claim, dated proof of purchase must accompany the product unless you have received written Return Material Authorization from Oztek stating that further proof of purchase is not required. Proof of purchase may be in any one of the following forms:

- The dated purchase receipt from the original purchase of the product at point of sale to the end user
- The dated dealer invoice or purchase receipt showing original equipment manufacturer (OEM) status
- The dated invoice or purchase receipt showing the product exchanged under warranty

What does this warranty not cover? Claims are limited to repair and replacement, or if in Oztek's discretion that is not possible, reimbursement up to the purchase price paid for the product. Oztek will be liable to you only for direct damages suffered by you and only up to a maximum amount equal to the purchase price of the product. This Limited Warranty does not warrant uninterrupted or error-free operation of the product or cover normal wear and tear of the product or costs related to the removal, installation, or troubleshooting of the customer's electrical systems. This warranty does not apply to and Oztek will not be responsible for any defect in or damage to:

- a) The product if it has been misused, neglected, improperly installed, physically damaged or altered, either internally or externally, damaged from improper use or use in an unsuitable environment, or operated outside of the specified safe operating temperature regions
- b) The product if it has been subjected to fire, water, generalized corrosion, biological infestations, or input voltage that creates operating conditions beyond the maximum or minimum limits listed in the Oztek product specifications including high input voltage from generators and lightning strikes
- c) The product if repairs have been done to it other than by Oztek or its authorized service centers (hereafter "ASCs")
- d) The product if it is used as a component part of a product expressly warranted by another manufacturer
- e) The product if its original identification (trademark, serial number) markings have been defaced, altered, or removed
- f) Any consequential losses that are attributable to the product losing power whether by product malfunction, installation error or misuse.

Disclaimer

Product

THIS LIMITED WARRANTY IS THE SOLE AND EXCLUSIVE WARRANTY PROVIDED BY OZTEK IN CONNECTION WITH YOUR OZTEK PRODUCT AND IS, WHERE PERMITTED BY LAW, IN LIEU OF ALL OTHER WARRANTIES, CONDITIONS, GUARANTEES, REPRESENTATIONS, OBLIGATIONS AND LIABILITIES, EXPRESS OR IMPLIED, STATUTORY OR OTHERWISE IN CONNECTION WITH THE PRODUCT, HOWEVER ARISING (WHETHER BY CONTRACT, TORT, NEGLIGENCE, PRINCIPLES OF MANUFACTURER'S LIABILITY, OPERATION OF LAW, CONDUCT, STATEMENT OR OTHERWISE), INCLUDING WITHOUT RESTRICTION ANY IMPLIED WARRANTY OR CONDITION OF QUALITY, MERCHANTABILITY OR FITNESS FOR A PARTICULAR PURPOSE. ANY IMPLIED WARRANTY OF MERCHANTABILITY OR FITNESS FOR A PARTICULAR PURPOSE TO THE EXTENT REQUIRED UNDER APPLICABLE LAW TO APPLY TO THE PRODUCT SHALL BE LIMITED IN DURATION TO THE PERIOD STIPULATED UNDER THIS LIMITED WARRANTY. IN NO EVENT WILL OZTEK BE LIABLE FOR: (a) ANY SPECIAL, INDIRECT, INCIDENTAL OR CONSEQUENTIAL DAMAGES, INCLUDING LOST PROFITS, LOST REVENUES, FAILURE TO REALIZE EXPECTED SAVINGS, OR OTHER COMMERCIAL OR ECONOMIC LOSSES OF ANY KIND, EVEN IF OZTEK HAS BEEN ADVISED, OR HAD REASON TO KNOW, OF THE POSSIBILITY OF SUCH DAMAGE, (b) ANY LIABILITY ARISING IN TORT, WHETHER OR NOT ARISING OUT OF OZTEK'S NEGLIGENCE, AND ALL LOSSES OR DAMAGES TO ANY PROPERTY OR FOR ANY PERSONAL INJURY OR ECONOMIC LOSS OR DAMAGE CAUSED BY THE CONNECTION OF A PRODUCT TO ANY OTHER DEVICE OR SYSTEM, AND (c) ANY DAMAGE OR INJURY ARISING FROM OR AS A RESULT OF MISUSE OR ABUSE, OR THE INCORRECT INSTALLATION, INTEGRATION OR OPERATION OF THE PRODUCT. IF YOU ARE A CONSUMER (RATHER THAN A PURCHASER OF THE PRODUCT IN THE COURSE OF A BUSINESS) AND PURCHASED THE PRODUCT IN A MEMBER STATE OF THE EUROPEAN UNION, THIS LIMITED WARRANTY SHALL BE SUBJECT TO YOUR STATUTORY RIGHTS AS A CONSUMER UNDER THE EUROPEAN UNION PRODUCT WARRANTY DIRECTIVE 1999/44/EC AND AS SUCH DIRECTIVE HAS BEEN IMPLEMENTED IN THE EUROPEAN UNION MEMBER STATE WHERE YOU PURCHASED THE PRODUCT. FURTHER, WHILE THIS LIMITED WARRANTY GIVES YOU SPECIFIC LEGAL RIGHTS, YOU MAY HAVE OTHER RIGHTS WHICH MAY VARY FROM EU MEMBER STATE TO EU MEMBER STATE OR, IF YOU DID NOT PURCHASE THE PRODUCT IN AN EU MEMBER STATE, IN THE COUNTRY YOU PURCHASED THE PRODUCT WHICH MAY VARY FROM COUNTRY TO COUNTRY AND JURISDICTION TO JURISDICTION.

Return Material Authorization Policy

Before returning a product directly to Oztek you must obtain a Return Material Authorization (RMA) number and the correct factory "Ship To" address. Products must also be shipped prepaid. Product shipments will be refused and returned at your expense if they are unauthorized, returned without an RMA number clearly marked on the outside of the shipping box, if they are shipped collect, or if they are shipped to the wrong location.

When you contact Oztek to obtain service, please have your instruction manual ready for reference and be prepared to supply:

- The serial number of your product
- Information about the installation and use of the unit
- Information about the failure and/or reason for the return
- A copy of your dated proof of purchase

Return Procedure

Package the unit safely, *using the original box and packing materials*. Please ensure that your product is shipped fully insured in the original packaging or equivalent. This warranty will not apply where the product is damaged due to improper packaging. Include the following:

- The RMA number supplied by Oztek clearly marked on the outside of the box.
- A return address where the unit can be shipped. Post office boxes are not acceptable.
- A contact telephone number where you can be reached during work hours.
- A brief description of the problem.

Ship the unit prepaid to the address provided by your Oztek customer service representative.

If you are returning a product from outside of the USA or Canada - In addition to the above, you **MUST** include return freight funds and you are fully responsible for all documents, duties, tariffs, and deposits.

Out of Warranty Service

If the warranty period for your product has expired, if the unit was damaged by misuse or incorrect installation, if other conditions of the warranty have not been met, or if no dated proof of purchase is available, your unit may be serviced or replaced for a flat fee. If a unit cannot be serviced due to damage beyond salvation or because the repair is not economically feasible, a labor fee may still be incurred for the time spent making this determination.

To return your product for out of warranty service, contact Oztek Customer Service for a Return Material Authorization (RMA) number and follow the other steps outlined in "Return Procedure".

Payment options such as credit card or money order will be explained by the Customer Service Representative. In cases where the minimum flat fee does not apply, as with incomplete units or units with excessive damage, an additional fee will be charged. If applicable, you will be contacted by Customer Service once your unit has been received.

Optional Extended Warranty

Limited Extended Warranty

What does this warranty cover and how long does it last? This Limited Extended Warranty is provided by Oztek Corp. ("Oztek") and covers defects in workmanship and materials in your PCS. This Warranty extends the duration of warranty protection period to 10 years from the date of purchase at the point of sale to you, the original end user customer, unless otherwise agreed in writing. This Extended Warranty does not increase the duration of coverage for the cooling fans, which are considered a wear item. You will be required to demonstrate proof of purchase to make warranty claims. This Limited Warranty is transferable to subsequent owners but only for the unexpired portion of the Warranty Period. Subsequent owners also require original proof of purchase as described in "What proof of purchase is required?"

What will Oztek do? During the Warranty Period Oztek will, at its option, repair the product (if economically feasible) or replace the defective product free of charge, provided you notify Oztek of the product defect within the Warranty Period, and provided that through inspection Oztek establishes the existence of such a defect and that it is covered by this Limited Warranty.

Oztek will, at its option, use new and/or reconditioned parts in performing warranty repair and building replacement products. Oztek reserves the right to use parts or products of original or improved design in the repair or replacement. If Oztek repairs or replaces a product, its warranty continues for the remaining portion of the original Warranty Period or 90 days from the date of the return shipment to the customer, whichever is greater. All replaced products and all parts removed from repaired products become the property of Oztek.

Oztek covers both parts and labor necessary to repair the product and return shipment to the customer via an Oztek-selected non-expedited surface freight within the contiguous United States and Canada. Alaska, Hawaii and locations outside of the United States and Canada are excluded. Contact Oztek Customer Service for details on freight policy for return shipments from excluded areas.

How do you get service? If your product requires troubleshooting or warranty service, contact your merchant. If you are unable to contact your merchant, or the merchant is unable to provide service, contact Oztek directly at:

USA
Telephone: 603-546-0090
Email techsupport@oztekcorp.com

Direct returns may be performed according to the Oztek Return Material Authorization Policy described in your product manual.

What proof of purchase is required? In any warranty claim, dated proof of purchase must accompany the product unless you have received written Return Material Authorization from Oztek stating that further proof of purchase is not required. Proof of purchase may be in any one of the following forms:

- The dated purchase receipt from the original purchase of the product at point of sale to the end user
- The dated dealer invoice or purchase receipt showing original equipment manufacturer (OEM) status
- The dated invoice or purchase receipt showing the product exchanged under warranty

What does this warranty not cover? Claims are limited to repair and replacement, or if in Oztek's discretion that is not possible, reimbursement up to the purchase price paid for the product. Oztek will be liable to you only for direct damages suffered by you and only up to a maximum amount equal to the purchase price of the product. This Limited Warranty does not warrant uninterrupted or error-free operation of the product or cover normal wear and tear of the product or costs related to the removal, installation, or troubleshooting of the customer's electrical systems. This warranty does not apply to and Oztek will not be responsible for any defect in or damage to:

- a) The product if it has been misused, neglected, improperly installed, physically damaged or altered, either internally or externally, or damaged from improper use or use in an unsuitable environment, or operated outside of the safe operating zones specified in the OZpcs-RS40 SB User's Manual.
- b) The product if it has been subjected to fire, water, generalized corrosion, biological infestations, or input voltage that creates operating conditions beyond the maximum or minimum limits listed in the Oztek product specifications including high input voltage from generators and lightning strikes
- c) The product if repairs have been done to it other than by Oztek or its authorized service centers (hereafter "ASCs")
- d) The product if it is used as a component part of a product expressly warranted by another manufacturer
- e) The product if its original identification (trademark, serial number) markings have been defaced, altered, or removed
- f) Any consequential losses that are attributable to the product losing power whether by product malfunction, installation error or misuse.

Disclaimer

Product

THIS LIMITED WARRANTY IS THE SOLE AND EXCLUSIVE WARRANTY PROVIDED BY OZTEK IN CONNECTION WITH YOUR OZTEK PRODUCT AND IS, WHERE PERMITTED BY LAW, IN LIEU OF ALL OTHER WARRANTIES, CONDITIONS, GUARANTEES, REPRESENTATIONS, OBLIGATIONS AND LIABILITIES, EXPRESS OR IMPLIED, STATUTORY OR OTHERWISE IN CONNECTION WITH THE PRODUCT, HOWEVER ARISING (WHETHER BY CONTRACT, TORT, NEGLIGENCE, PRINCIPLES OF MANUFACTURER'S LIABILITY, OPERATION OF LAW, CONDUCT, STATEMENT OR OTHERWISE), INCLUDING WITHOUT RESTRICTION ANY IMPLIED WARRANTY OR CONDITION OF QUALITY, MERCHANTABILITY OR FITNESS FOR A PARTICULAR PURPOSE. ANY IMPLIED WARRANTY OF MERCHANTABILITY OR FITNESS FOR A PARTICULAR PURPOSE TO THE EXTENT REQUIRED UNDER APPLICABLE LAW TO APPLY TO THE PRODUCT SHALL BE LIMITED IN DURATION TO THE PERIOD STIPULATED UNDER THIS LIMITED WARRANTY. IN NO EVENT WILL OZTEK BE LIABLE FOR: (a) ANY SPECIAL, INDIRECT, INCIDENTAL OR CONSEQUENTIAL DAMAGES, INCLUDING LOST PROFITS, LOST REVENUES, FAILURE TO REALIZE EXPECTED SAVINGS, OR OTHER COMMERCIAL OR ECONOMIC LOSSES OF ANY KIND, EVEN IF OZTEK HAS BEEN ADVISED, OR HAD REASON TO KNOW, OF THE POSSIBILITY OF SUCH DAMAGE, (b) ANY LIABILITY ARISING IN TORT, WHETHER OR NOT ARISING OUT OF OZTEK'S NEGLIGENCE, AND ALL LOSSES OR DAMAGES TO ANY PROPERTY OR FOR ANY PERSONAL INJURY OR ECONOMIC LOSS OR DAMAGE CAUSED BY THE CONNECTION OF A PRODUCT TO ANY OTHER DEVICE OR SYSTEM, AND (c) ANY DAMAGE OR INJURY ARISING FROM OR AS A RESULT OF MISUSE OR ABUSE, OR THE INCORRECT INSTALLATION, INTEGRATION OR OPERATION OF THE PRODUCT. IF YOU ARE A CONSUMER (RATHER THAN A PURCHASER OF THE PRODUCT IN THE COURSE OF A BUSINESS) AND PURCHASED THE PRODUCT IN A MEMBER STATE OF THE EUROPEAN UNION, THIS LIMITED WARRANTY SHALL BE SUBJECT TO YOUR STATUTORY RIGHTS AS A CONSUMER UNDER THE EUROPEAN UNION PRODUCT WARRANTY DIRECTIVE 1999/44/EC AND AS SUCH DIRECTIVE HAS BEEN IMPLEMENTED IN THE EUROPEAN UNION MEMBER STATE WHERE YOU PURCHASED THE PRODUCT. FURTHER, WHILE THIS LIMITED WARRANTY GIVES YOU SPECIFIC LEGAL RIGHTS, YOU MAY HAVE OTHER RIGHTS WHICH MAY VARY FROM EU MEMBER STATE TO EU MEMBER STATE OR, IF YOU DID NOT PURCHASE THE PRODUCT IN AN EU MEMBER STATE, IN THE COUNTRY YOU PURCHASED THE PRODUCT WHICH MAY VARY FROM COUNTRY TO COUNTRY AND JURISDICTION TO JURISDICTION.